

▶ **Extrusion  
coating and  
laminating**

# Coating Lines



Turning complexity  
into productivity

**The performance of an extrusion line has a noticeable impact on every company's budget. Nothing is more expensive than rejects. SML advises its customers to invest in the perfect machine from the outset. An extensive portfolio of coating and laminating lines is available for our customers.**

From the extruder, the unwinder and laminator to the winders and the system control – SML designs and manufactures everything in-house. Our extrusion coating and laminating solutions are characterised by technical precision, reliability and easy operability. Above all, it is our human centered approach in combination with decades of experience and the constant drive for innovation, that makes the difference in this complex market segment.

#### **Manifold applications possible**

SML provides customised all-in solutions for nearly every application. This covers various types of packaging materials for the food industry as well as laminates for hygiene applications, for construction, for the textile industry and for the automotive sector.

#### **Extraordinary joining of materials**

Unparalleled extrusion lamination solutions, new to the market, are now possible thanks to a sophisticated design and the ultra-precise interaction of high-performance components. These include extremely thin laminates with an extraordinary breathability or the development of machinery allowing the joining of materials which were considered incompatible.

#### **Machine control and operation concept**

For SML, extrusion lamination does not merely consist of glueing substrates together. In combination with SML's completely in-house developed machine control system SMILE, extrusion coating and laminating lines from SML empower manufacturers to shape the properties of end products to meet their needs.

Thanks to SMILE, components from sub-suppliers can be integrated in the lines and precise settings for product changes can be managed easily with a minimum of time expenditure.

#### **Data analysis**

SML's data generation and analysis tool, bitWise, provides entirely new opportunities for data driven decision making with a clear focus on the optimisation of production processes and the final product.

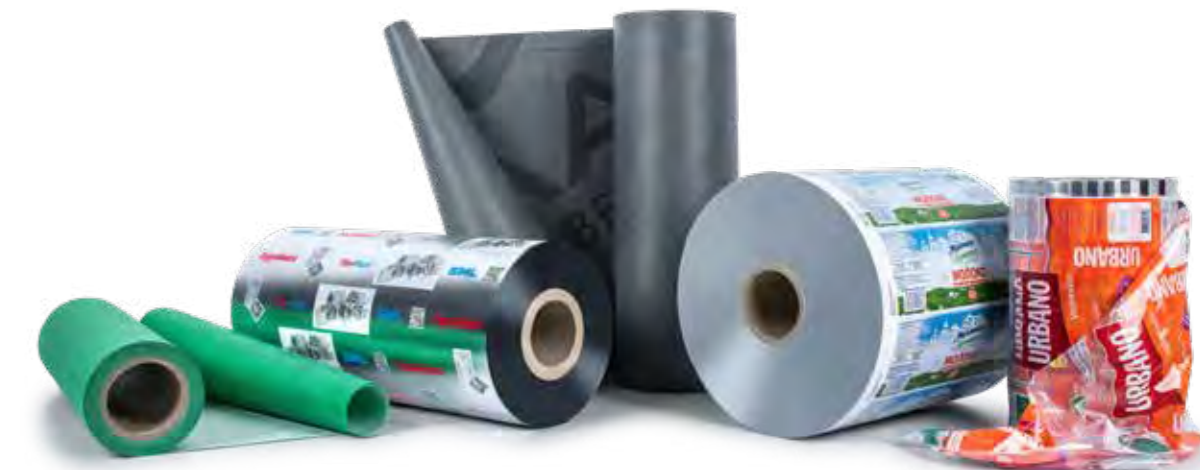

# Content

Line Description ▶ 8



Products ▶ 9

Unwinder ▶ 15

Winder ▶ 25

FlexPack® ▶ 32



Triplex ▶ 36



DoubleCoat ▶ 38



Extra Wide Lines ▶ 40

Process Combinations and Integrations ▶ 42

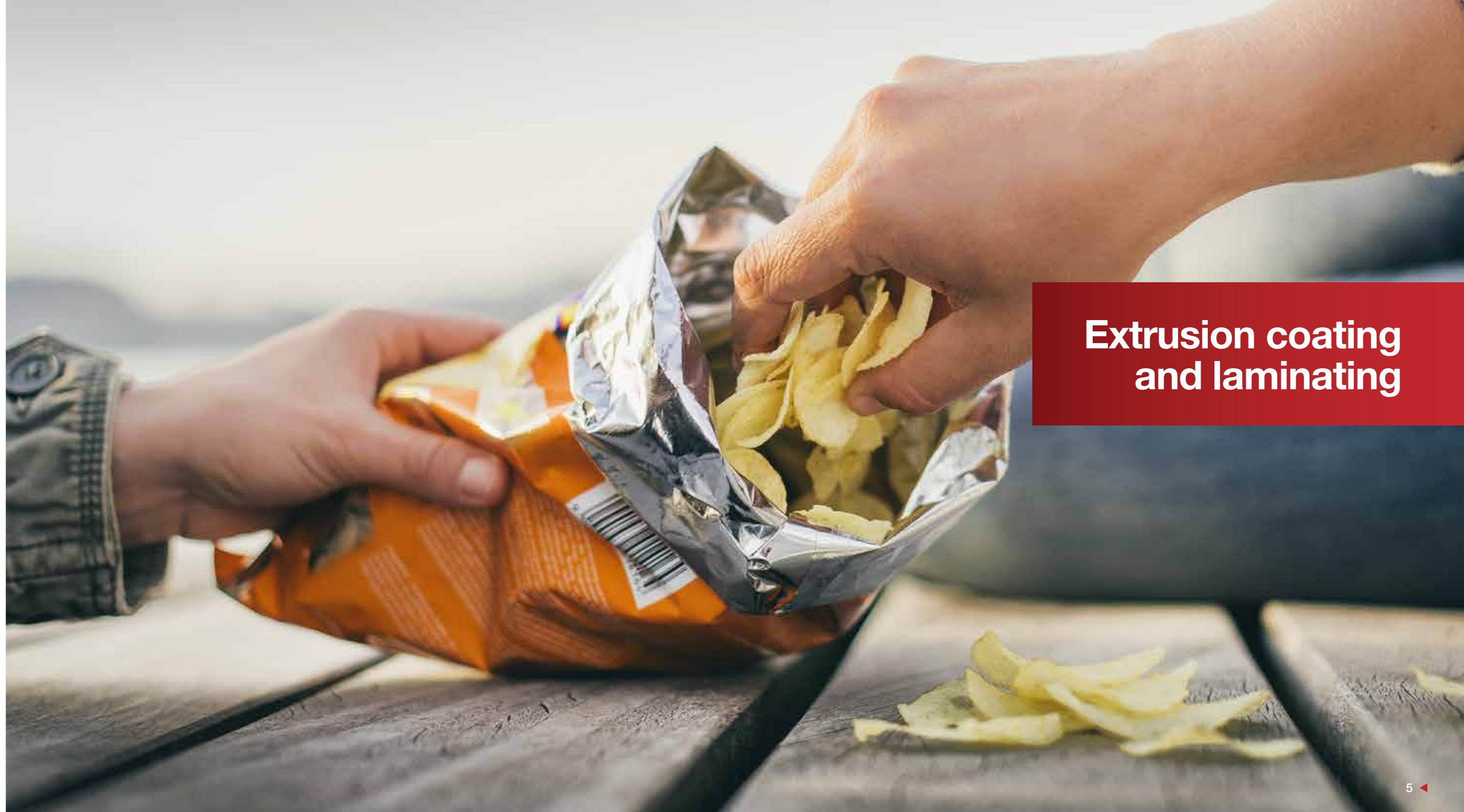

**Extrusion coating  
and laminating**

# The core of our idea: Lines for extrusion coating & laminating

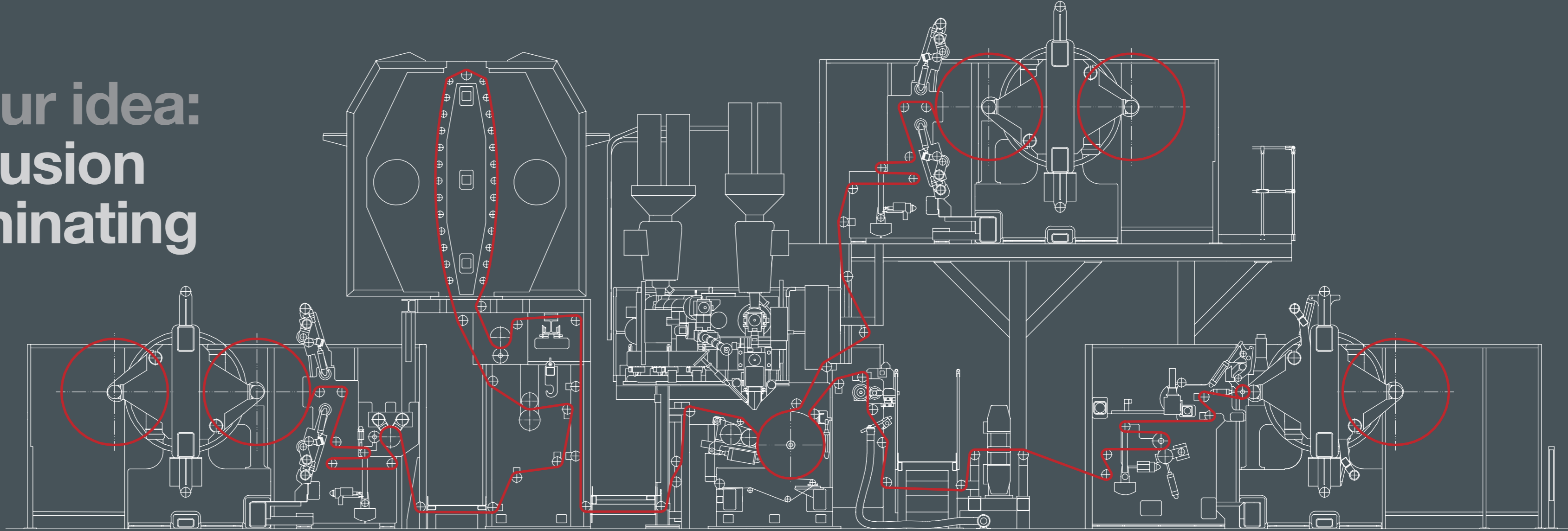

# Overview

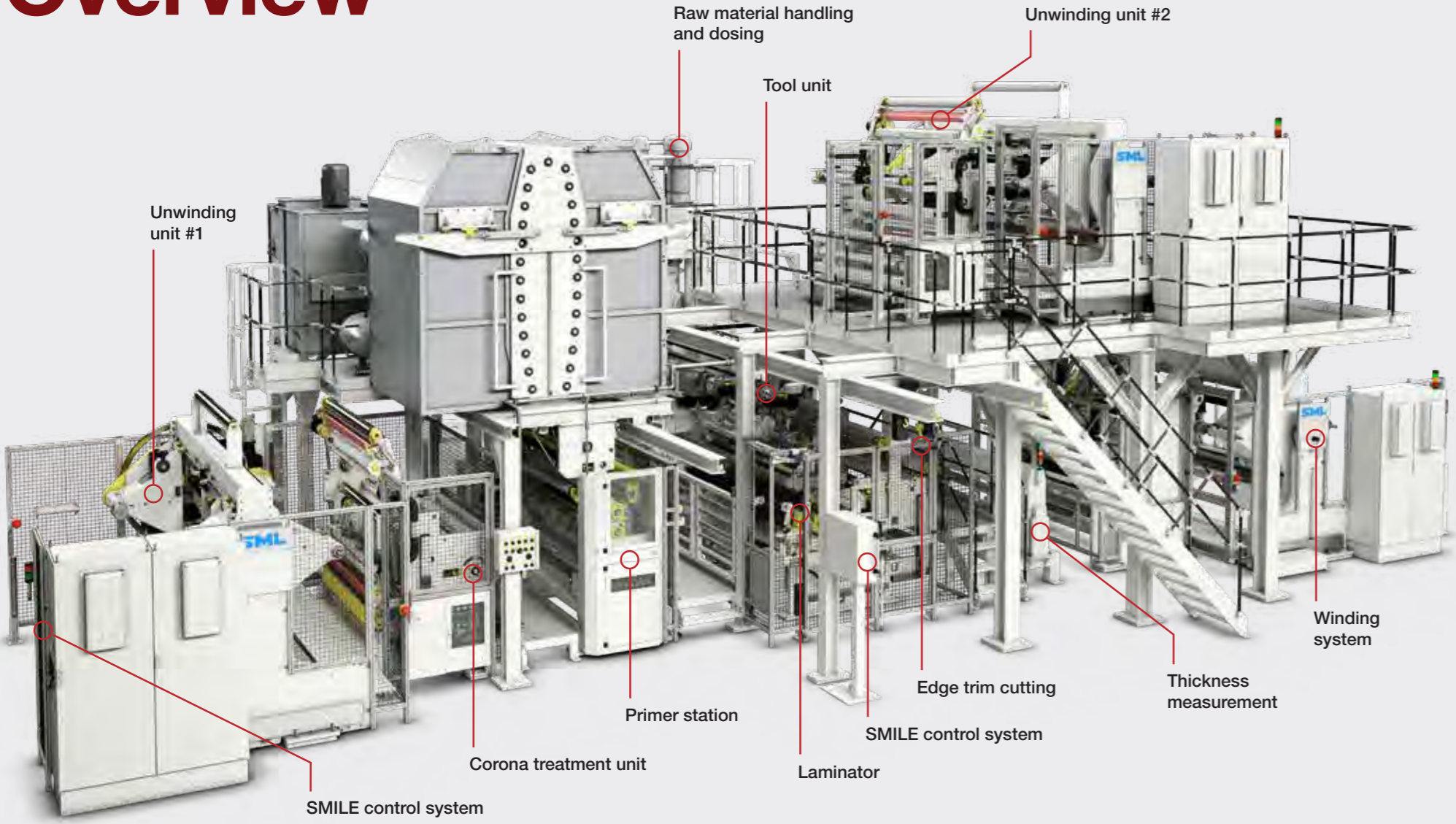

# Typical Products





# Highly accurate dosing Raw material

SML's gravimetric batch blenders and continuous gravimetric feeders guarantee material blending accuracy of the highest level. Up to six components per extruder can be processed, providing a maximum of flexibility.

## Permanent output control

The continuous communication between the dosing and the extruder control system guarantees a constant and precise extruder output.

## Exact repeatability of recipes

SML's complete dosing system, as well as all the material supply vacuum pumps, filters and valves are fully integrated in the SMILE machine control system. This allows the accurate reproducibility of recipes, making changes in production very fast and easy to implement at the operational level. At the same time, waste production is reduced to a minimum.

## Your Advantages

- ▶ Highest material blending accuracy
- ▶ Up to six different components per extruder
- ▶ SMILE control system for fast and efficient product changes

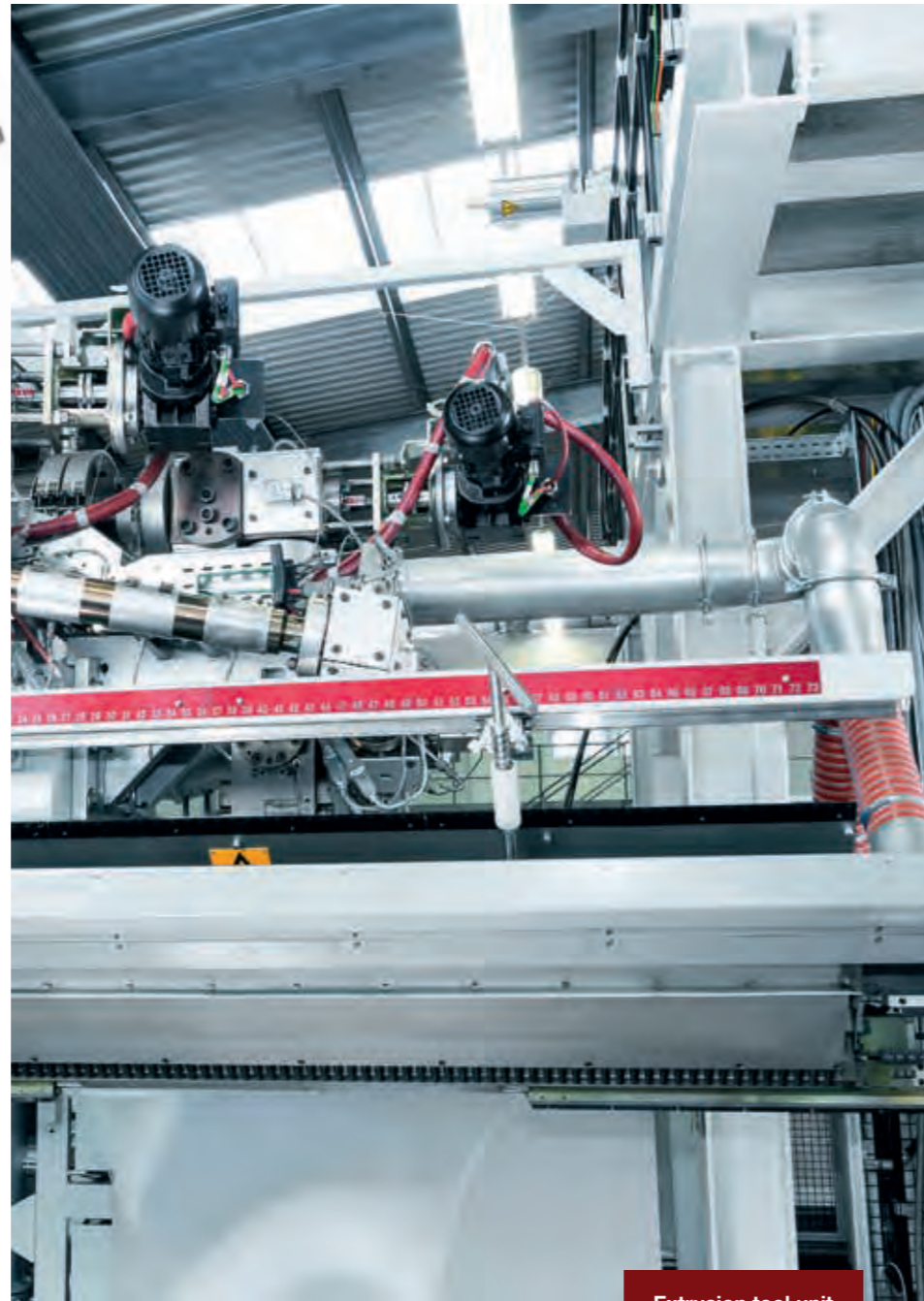

Extrusion tool unit

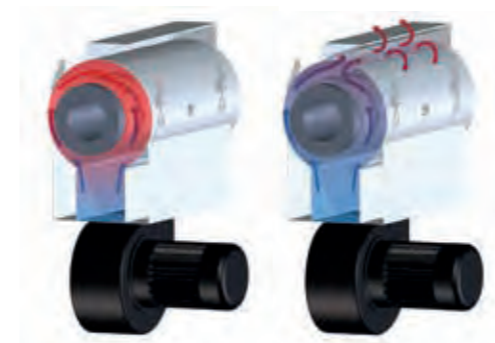

# Always state-of-the-art Extrusion

Extrusion systems developed by SML stand for technical precision, field-tested reliability and constant innovations. It is SML's long-time experience in screw design in combination with in-house testing facilities, that helps to create outstanding extrusion solutions for any polymer in coating or lamination.



Advanced heating/cooling system

## Choices for each type of polymer

SML offers a customer-specific extruder design for all polymer types. As a standard, a choice of screw diameters from 45 mm to 220 mm is available. The L/D ratio can be 28 or 33, whereby 33 is the preferred solution to obtain a high melt temperature and excellent mixing results even at high speeds.

## Optimised energy efficiency

The extruders are driven by energy-efficient, low-maintenance, water-cooled AC motors as a standard. All extruder barrels are heated using SML's advanced heating system. A flap, which closes through gravity preventing the escape of warm air from the system and retaining the heat in the barrel.

## Your Advantages

- ▶ Specific extruder designs for all types of raw material
- ▶ Superior melt quality

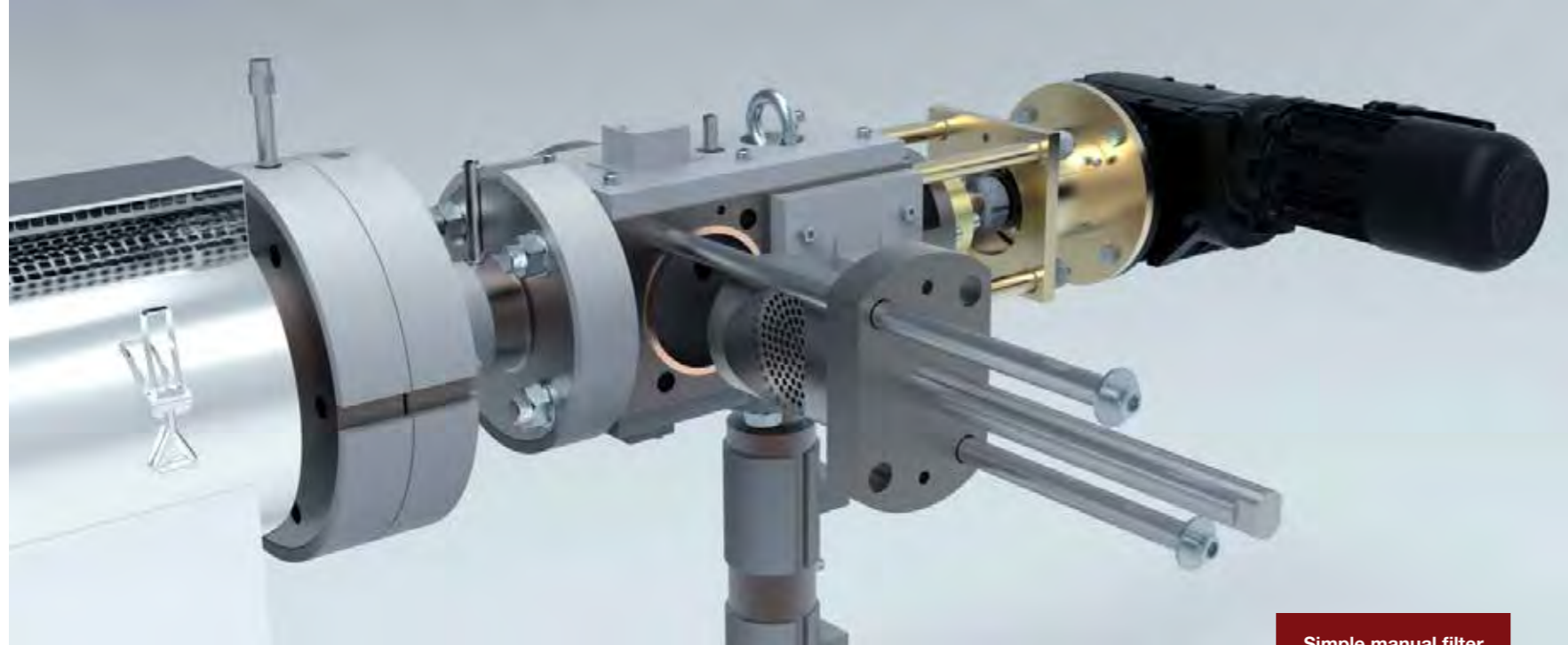

Simple manual filter

## This is how we avoid impurities

# Melt filtration

Effective melt filtration is a crucial issue when it comes to stable production processes and an excellent melt quality. For the removal of impurities, such as unmelted or cross-linked particles, SML offers a variety of solutions. Simple manual filters can be used for standard virgin coating grades, while SML usually installs hydraulic, single-piston filters for materials requiring more frequent filter changes. For special applications, i. e. when a substantial share of recycled materials is processed, continuous filtration systems are used.

### Melt pressure regulation valve

An adjustable melt pressure valve can be integrated downstream from the filter. This allows the adjustment of extruder backpressure, which can have a beneficial effect on shear rates. Improved mixing results can thus be achieved regardless of whether there is high or a low output. Using a melt pressure valve also helps to increase the melt temperature to achieve optimised adhesion properties.

### Your Advantages

- ▶ Selection of different melt filtration systems depending on the material processed
- ▶ Adjustable melt pressure valve downstream of the filter
- ▶ Motorised back pressure adjustment

## Different options, always optimised for your needs

# Feedblock and flat die



Flat die with fume suction hood

SML relies exclusively on respected partners for its feedblocks and flat dies. Multilayer structures require great flexibility with regard to feedblock adjustment. Therefore, as a rule, SML utilises variable geometry feedblocks and inserts that can be profiled to optimise the thickness tolerances of the individual layers.

### T-channel dies with internal and external deckling systems

SML offers different die designs in line with the respective application. Extrusion coating systems need to run with various product widths and therefore, die deckling is required. Flat dies with a coat hanger design have good distribution characteristics but can only be deckled with external decklings. Therefore, in recent years, the trend has been towards T-channel dies with internal and external decklings. The internal deckling consists of individually adjustable blades. This has the positive effect of influencing the edge bead and the neck-in of the melt curtain, which reduces the waste from overcoating. Profile adjustments can either be done with a manual or automatic die control via thermally heated bolts.

Depending on the manufacturer, dies are either chrome or nickel plated. In applications where the extrudate is corrosive, stainless steel may be selected as a base material.

### Fume suction as a standard

SML provides fume suction in all of its extrusion coating lines. As an option, an additional electrostatic filtering system can be equipped with HEPA (high efficiency particulate air filter) filters to clean the exhaust air, minimising adverse health effects and making over-all production more eco-friendly.

### Your Advantages

- ▶ High-end flat dies from respected partners
- ▶ Various types of deckling systems
- ▶ Manual or automatic die bolt control

# Extruder carriage

The extrusion units in SML's coating and laminating lines can be easily moved into an offline service position, i. e. to have access for die lip cleaning. SML offers two types of extruder carriages: a floor carriage with in-floor rails and a hanging extruder platform. The floor carriage allows perfect access to all of the equipment installed from the top, while a hanging extruder platform offers perfect stiffness for wide coating lines.

## Recipe management for coating positions

As the relative position between the die exit and the point of melt contact with the substrate is an important process parameter that must be altered for different materials, the extruder carriage is adjustable in all three axes. For good repeatability, the actual positions are detected, displayed and stored in recipes.

## Your Advantages

- ▶ Floor carriage with in-floor rails for optimal access from the top
- ▶ Hanging extruder platform for best stiffness for wide coating lines
- ▶ Oscillating extrusion units for an optimised reel profile

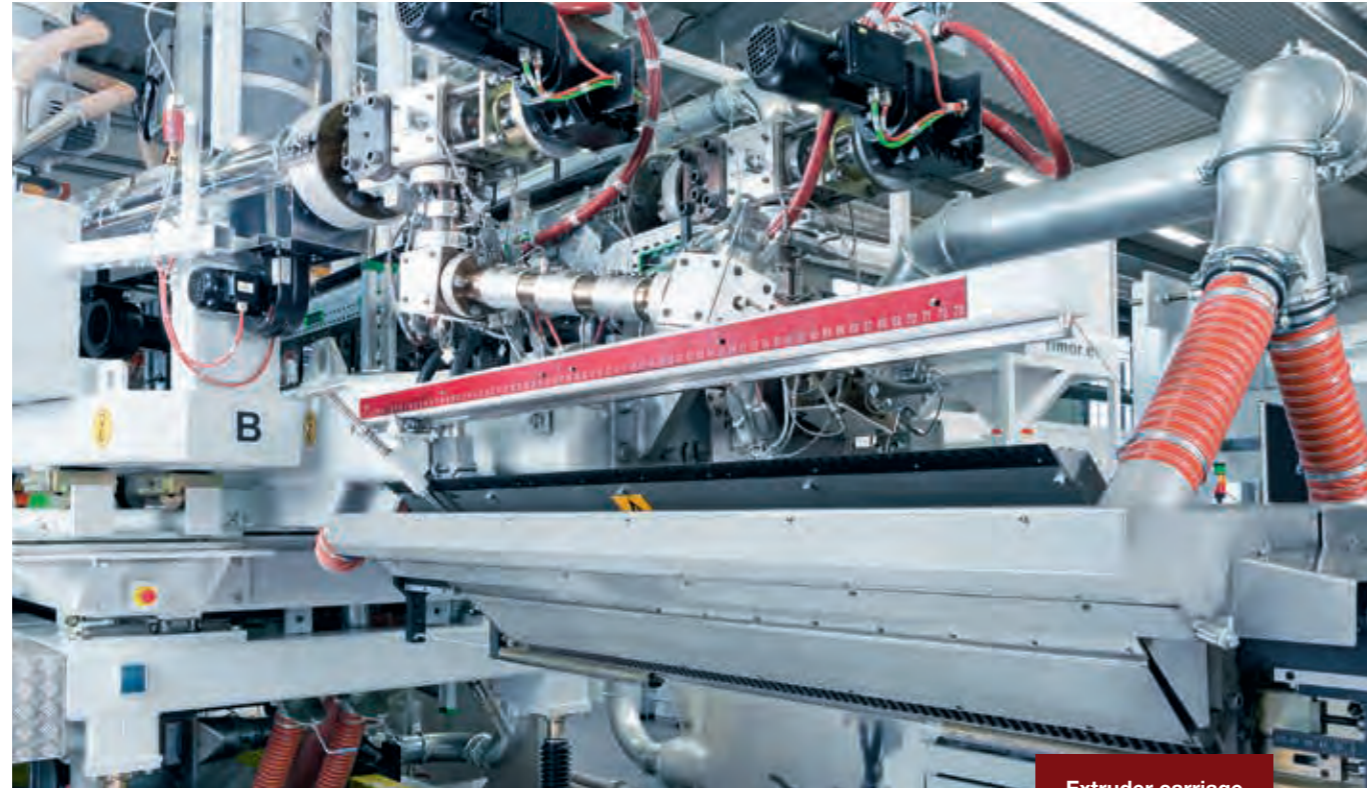

Extruder carriage

# Open to extensions Unwinding equipment

Precise and reliable working unwinders are an essential part of any extrusion coating process. They guarantee substrate roll changes up to full production speed, preventing down-times and start-up waste. Depending on the structure of the products, a maximum of four unwinders can be installed in parallel in SML's extrusion coating and lamination lines.

SML offers various types of unwinds for every requirement in production and for any type of substrate.

- ▶ Simple double-station unwinds with a manual splicing unit
- ▶ Zero-speed splicers with thermo-welding or butt splice with festoon
- ▶ Fully automatic turret unwinders, shafted or shaftless

## Sensitive tension control

All SML turret unwinders are equipped with a lightweight dancer roll for sensitive tension control, while the substrate roll is centre-driven by an AC servo motor. During splicing, the new roll is automatically synchronised with the line speed. Splicing is carried out with a driven bump roll and a pneumatically operated chopping knife. With a defined splice geometry and position detection, the splice length is minimised.

## Modular set-up

All fully automatic turret unwinders are built in a modular design, which allows adding special features to the basic machine. If needed, a second splicing unit for bi-directional unwinding, integrated edge guiding or an optional constant gap device for the smooth unwinding of thin, sensitive aluminium foil, can be installed optionally.

The unwinders in SML's lines for coating and lamination are equipped with a separate control cabinet and their own PLC system. The local control unit of the unwind is 100 % synchronised with SMILE, the comprehensive over-all control system of the line.



# Find the perfect unwinder for your application

| Unwinder type               | Double unwinder     | UW1500 WS      | UW1500 SL                    | UW1500 SL-H                  |
|-----------------------------|---------------------|----------------|------------------------------|------------------------------|
| Maximum mechanical speed    | 150 m/min           | 350 m/min      | 450 m/min                    | 600 m/min                    |
| Maximum substrate width     | 5,200 mm            | 1,800 mm       | 2,400 mm                     | 4,500 mm                     |
| Maximum mechanical diameter | 1,500 mm            | 1,200 mm       | 1,270 mm                     | 1,600 mm                     |
| Core clamping               | shafted / shaftless | shafted        | shaftless                    | shaftless                    |
| Maximum roll weight         | 4,500 kg            | 1,500 kg       | 2,000 kg                     | 4,000 kg                     |
| Unwinding direction         | both                | both           | both                         | both                         |
| Roll handling               | crane               | crane/forklift | crane/forklift/lifting table | crane/forklift/lifting table |

## UW 1500 WS

The turret unwinder UW 1500 WS is a **cost-efficient solution** with a special circular adapter for the fully automatic unwinding of substrates with winding shafts.

It is capable of production speeds of up to 350 m/min and can be used for substrates with a maximum roll diameter of 1,200 mm. Splicing can be done up to full production speed. For the optimal centring of the substrate roll, winding shafts with a special circular adapter, in combination with sliding safety chucks, are used for core fixation.

The complete unwinder is mounted on linear guides. An integrated edge guiding system ensures the correct alignment of the substrate. Therefore, no additional web positioning equipment is required. The design enables easy roll handling with standard electric forklifts.

### Your Advantages

- ▶ Fully automatic unwinding with winding shafts
- ▶ Cost efficient solution for roll diameters up to 1,200 mm
- ▶ Integrated edge guiding system



# UW 1500 SL

The turret unwinder UW 1500 SL is a **shaftless unwinding** system with production speeds of up to 450 m/min and for maximum roll diameters of 1,270 mm.

Core clamping is done with mechanically actuated chucking heads of different sizes, which can be easily changed. Each unwinding position is motorised in the transverse direction.

## Integrated web guiding equipment

By moving both chucking head supports in the transversal direction, substrate can be positioned with precision, thus avoiding the need for additional web guiding equipment. Furthermore, this design facilitates easy roll handling with standard electric forklifts.

## Your Advantages

- ▶ Fully automatic unwinding for speeds up to 450 m/min
- ▶ Shaftless operation using mechanically actuated chucking heads
- ▶ Easy roll handling with standard electric forklifts



# UW 1500 SL-H

The turret unwinder UW 1500 SL-H is the right answer **for heavy substrates** and large roll diameters. It handles widths up to 4,500 mm and maximum roll diameters of 1,600 mm.



Splicing can be done up to full production speed. Core clamping is shaftless and employs mechanically actuated chucking heads of various sizes.

## Maximum roll handling flexibility

Integrated lifting tables can be utilised for loading and unloading, which leads to maximum roll handling flexibility in combination with minimum handling times. Each unwinding support is motorised in the transverse direction and can be linked to an edge guiding system for the appropriate positioning of the substrate. As a result, no additional web guiding equipment is necessary.

## Your Advantages

- ▶ Designed for heavy substrate rolls and widths up to 4,500 mm
- ▶ Shaftless core clamping with mechanically actuated chucking heads
- ▶ Integrated lifting tables for fast and comfortable roll handling

# The heart of the line Laminator

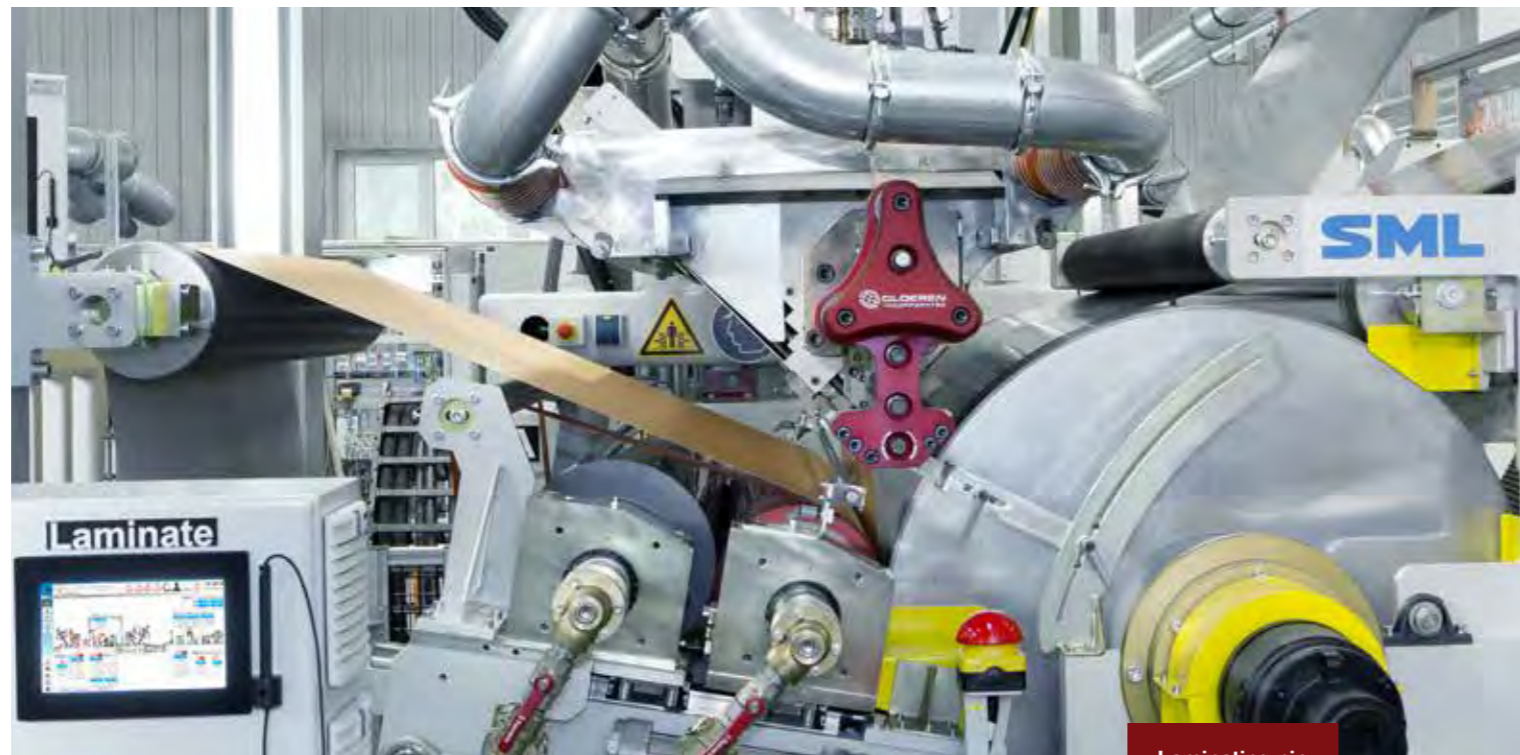

Laminating nip

The laminator is the key component of any extrusion coating line, combining all different types of substrates to one single product structure. SML's laminators all have massive side frames which are directly mounted to the floor to ensure vibration-free production.

## Precise roll arrangement

A pressing unit, consisting of a rubber roll and a steel supporting roll, is arranged on linear guides to precisely apply a defined pressure to the coating gap between the rubber roll and the chill roll. All rolls are equipped with quick change couplings in order to complete roll changes and perform product surface changes in minimum time.

## Minimised substrate waste

An endless PTFE tape allows overcoating to minimise substrate waste. An adjustable stripper roll at the outlet of the unit ensures the consistent peel-off of the coated material from the chill roll.

## Recipe management for exact repeatability

All parameters which have a direct impact on product properties, are comfortably adjustable with SML's advanced machine control system, SMILE – i. e. the position of the die or the pressing force or the chill roll temperature. For an exact repeatability, all of the settings of the laminator can be stored in recipes.

## Your Advantages

- ▶ Massive side frames for vibration-free production
- ▶ Quick roll changes for fast product changes
- ▶ Waste reduction with PTFE tape attachment

# Thickness measurement

As a response to the differing local regulations and specific product requirements, SML supplies automatic gauging systems with infrared, X-ray or Beta ray sensors.

Apart from single-frame solutions with total product measurements, SML also offers multiple frame systems for differential thickness measurements. All of the frames are synchronised to ensure measurements of the same spot. This is necessary to maintain a constant coating thickness, even when the substrate thickness has variations.

## Your Advantages

- ▶ Automatic gauging systems with infrared, X-ray or Beta ray sensors
- ▶ Single-frame solutions with total product measurements
- ▶ Differential measurement system for a constant overall coating weight



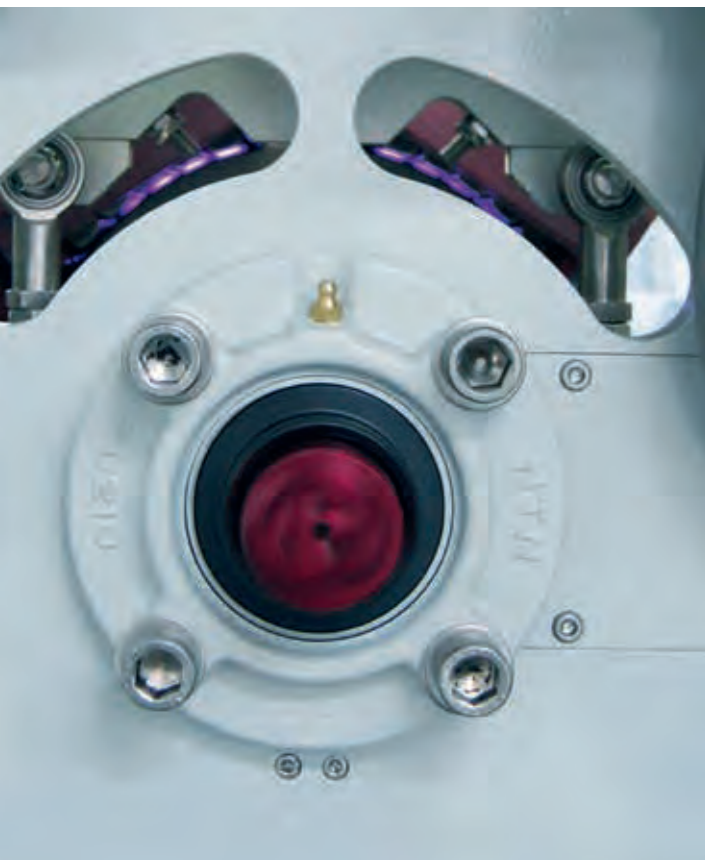

## Keeping the process smooth

# Corona treatment station

A corona treatment modifies the surface tension of the product. It can be installed upstream of the substrates, to increase the bonding strength, and downstream to improve printability on the final product. In most of SML's coating lines for coating and laminating, the corona treatment unit is mechanically fully integrated in the unwind side frames. This helps to shorten the web-path and to minimise the total length of the line.

Depending on the conductivity of the material to be treated, either ceramic or stainless steel electrodes are used. Each station can be driven and fitted with a rubber pressing roll to avoid backside treatment and to separate and control the web tension. The control system of the corona treatment unit is fully integrated in SML's overall machine control system SMILE, making operation extremely comfortable.

### Your Advantages

- ▶ Corona treatment unit up- and downstream for specific adhesion and printing properties
- ▶ Fully integrated in the unwind side frames for a short web-path
- ▶ Easy and simple to operate with SML's machine control system, SMILE

## Primer station

To enhance adhesion, it is possible to apply a liquid primer coating to the pre-treated substrate surface. The primer layer is applied by a roller coating system with a gravure roller and a closed chamber doctor blade onto the substrate. Compared to conventional smooth roll systems, this method offers the highest precision, increased production speed and less spillage.

### Improved energy efficiency

The liquid is evaporated in a subsequent vertical drier and leaves a thin layer of solids on the surface, as an anchor for further processes. Since drying is an energy-intensive process, SML only uses highly efficient equipment with adjustable return air and optimised flow speeds. Heating sources can be either electric, gas, oil or steam – depending on customer requirements.

### Your Advantages

- ▶ Gravure roll coating system with closed doctor chamber blade
- ▶ Highest precision, production speed and less spillage
- ▶ Energy efficient drying process



## Trim handling systems

Within SML's extrusion coating lines, the edges of the product are trimmed immediately after the laminator. Most products are wound as a mother roll, but also inline slitting can be offered.

For these products which are not suitable for recycling, the cut trim is waste and therefore must be minimised. Precisely adjustable circular knives with driven counter knives give an optimum result.

After cutting, the trims are sucked off and can be cut into small pieces, to minimise the volume required for storing and transportation.

### Your Advantages

- ▶ Edge trimming immediately after the laminator
- ▶ Precisely working circular knife system for optimal cutting
- ▶ Waste reduction through minimised edge trims



## Ready to handle high speed Winding Systems

Winders engineered by SML stand for an unparalleled precision and for the best operational stability.

Over the years, SML has invested an enormous amount of effort into building its own peak performance winders for various applications. All these winders have a solid, vibration-dampening steel frame construction, that is especially designed to resist the dynamic forces generated at high production speeds.

### 100 % synchronised with SMILE

The winders in SML's lines for coating and lamination are equipped with a separate control cabinet and their own PLC system. The local control unit of the winder is 100 % synchronised with SMILE, the comprehensive overall control system of the line. Operator convenience is guaranteed by a self-explanatory and easy to operate user interface on a wide touch screen.

# Find the right winder for your application

| Winder type                 | W1500 WS      | W1500 SL      | W1800            | W2000            |
|-----------------------------|---------------|---------------|------------------|------------------|
| Maximum mechanical speed    | 350 m/min     | 450 m/min     | 600 m/min        | 600 m/min        |
| Maximum winding width       | 1,800 mm      | 2,400 mm      | 4,800 mm         | 2,900 mm         |
| Inline slitting             | No            | No            | Yes              | Yes              |
| Maximum mechanical diameter | 1,200 mm      | 1,270 mm      | 1,800 mm         | 980 or 1,500 mm  |
| Maximum roll weight         | 1,500 kg      | 2,000 kg      | 4,000 kg         | 2,500 kg         |
| Winding direction           | both          | both          | top wound inside | top wound inside |
| Winding tension             | 50 - 750 N    | 50 - 750 N    | 50 - 3,500 N     | 30 - 300 N       |
| Contact roll pressure       | 100 - 1,800 N | 100 - 1,800 N | 50 - 3,500 N     | 50 - 500 N       |
| Roll handling               | manual        | manual        | automatic        | fully automatic  |

## Winder **W1500 WS**

The turret winder W1500 WS is designed for production speeds of up to 350 m/min and can be used for products with a maximum roll diameter of 1,200 mm.

Reel change is done at full production speed. Winding shafts with a special circular adapter are used in combination with sliding safety chucks for core fixation.

### Winding in gap and contact mode

A fixpoint unit at the winder inlet separates the web and winding tension. A lightweight dancer roll controls the winding tension, while the roll is centre driven by an AC servomotor. Winding can be done in gap or contact mode.

### Winding in both directions

Cross-cutting systems with flying or chopping knives are available for smooth roll changes. In order to satisfy individual requirements, rolls can be wound in both directions by means of an optional second cutting unit. This design facilitates easy roll handling with standard electric forklifts.

### Your Advantages

- ▶ Especially for the production of mother rolls in the medium speed range
- ▶ Cross cutting system with flying or chopping knives
- ▶ Fixpoint to separate the web and winding tension

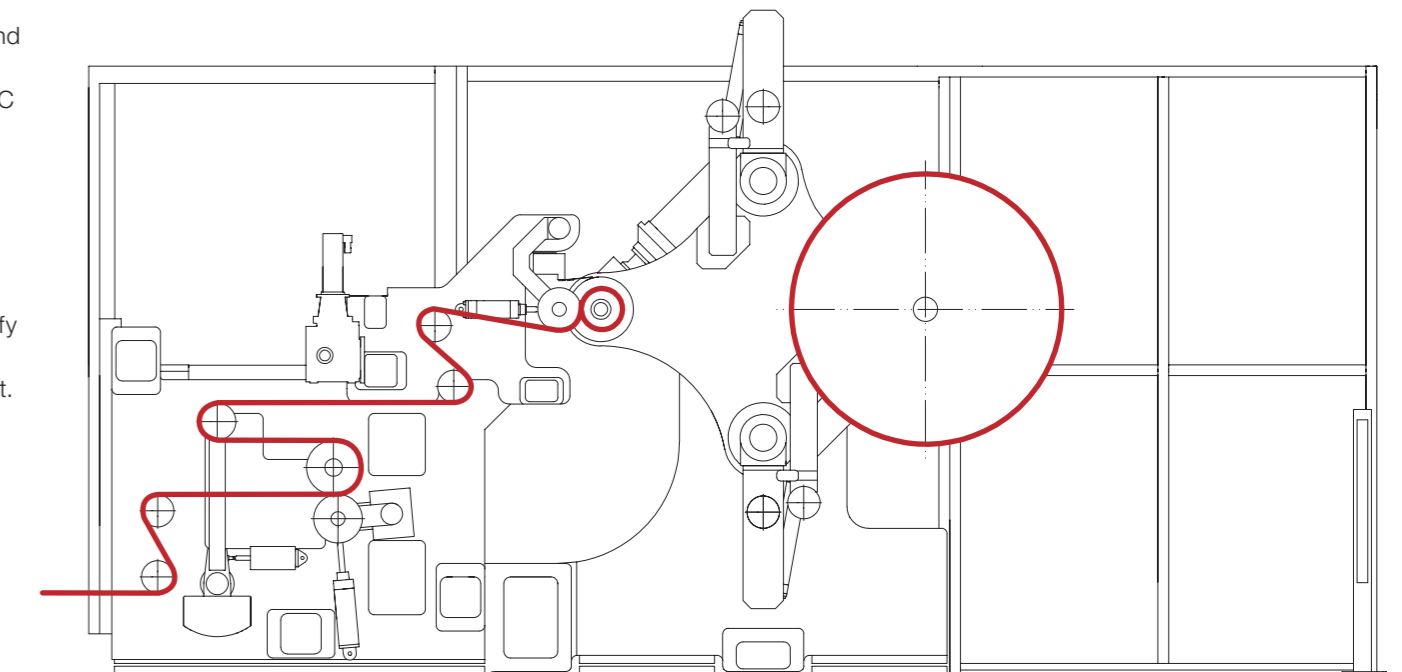

# Winder W1500 SL

The turret winder W1500 SL is designed for production speeds of up to 450 m/min and maximum roll diameters of 1,270 mm.

Core clamping is done without a shaft and uses mechanically actuated chucking heads of different sizes, which can be easily exchanged.

The winder can be equipped for single or dual directional winding. With two different cutting systems available, it can be adapted to the respective customer needs.

## Your Advantages

- ▶ Shaftless winding system for higher production speeds
- ▶ Two different cutting systems available
- ▶ Dual direction winding

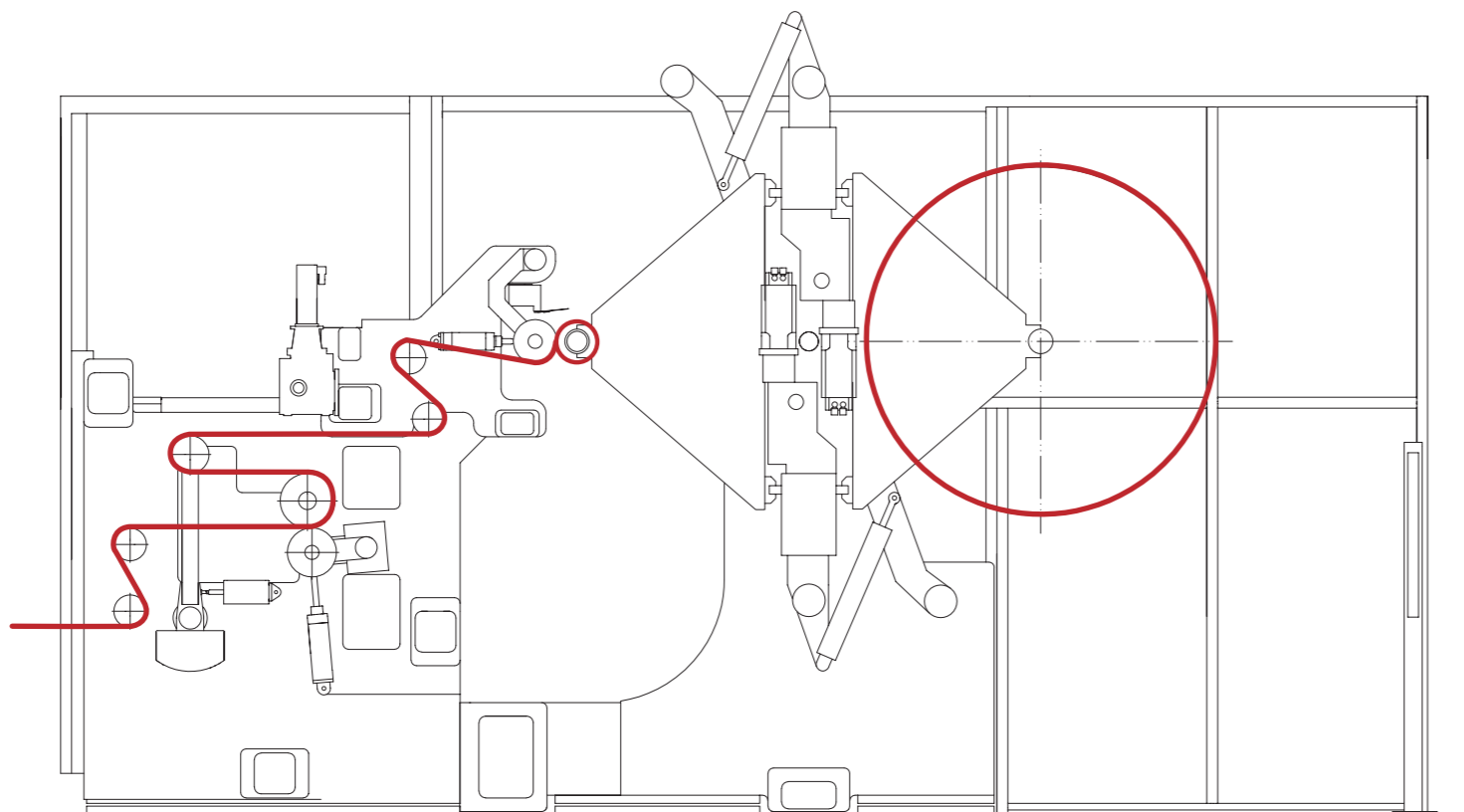

# Winder W1800

The surface driven drum winder W1800 is for large widths of up to 4,800 mm and maximum roll diameters of 1,800 mm.

Apart from a turret winder, the winder W1800 is surface driven. The applied power of the contact winder motor does not have to be raised in accordance with increasing roll diameters. This permits a considerable reduction in both the motor power installed and the related energy consumption. For maximum flexibility, the drum winder can also be equipped with a centre drive for the shaft as an option.

## Cross cutting with chopping or flying knives

Depending on the application, cross-cutting is done using a guillotine or a flying knife. Both versions are equipped with a satellite unit, which orbits the contact roll as a counter support on the winding drum for optimised cutting geometry.

## Automatic shaft and reel handling system

This winder is operated with winding shafts. An automatic shaft and reel handling system is available as an option to ease the handling of heavy rolls and shafts.

## Inline-slitting

The winder W1800 is optimal for inline slitting, since there is no turret rotation during change-over. The inline-slitting process can be carried out either with or without bleed trims.

## Your Advantages

- ▶ Designed for heavy product rolls and diameters up to 1,800 mm
- ▶ Surface driven, with minimal energy consumption
- ▶ Draw unit to separate the web and winding tension

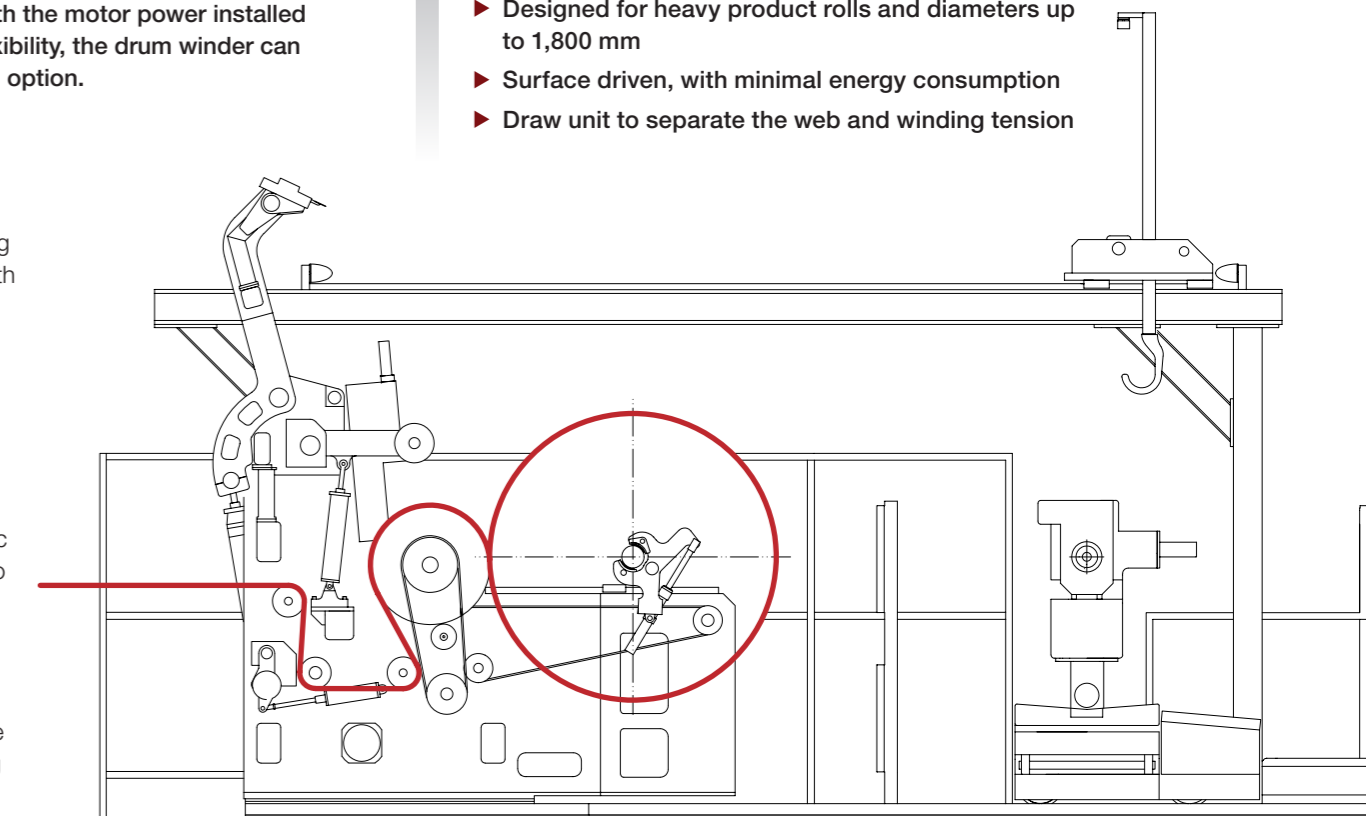

# Winder W2000 robotic

The winder W2000 robotic is the standard horizontal sliding winder for the inline-slitting of rolls.

Due to the principle of a horizontal winding position movement, the roll remains in an optimum winding position until the very last moment before cross-cutting, thus guaranteeing a perfect winding quality up to the last layer of the roll.

## No core preparation necessary

The winder W2000 robotic is designed for the winding of laminates in a wide thickness range. It is equipped with an ultra-lightweight dancer roll for sensitive tension control and can be operated in the gap or contact mode. A satellite roll optimises the entrance angle of the film to the roll, which minimises the air entrapment. A strong guillotine knife is used for cross-cutting. The film is fixed onto the new winding core with a belt cage and compressed air nozzles. As a result, core preparation is unnecessary.

## Inline-slitting

The winder 2000 robotic is optimal for inline slitting, since there is no turret rotation during change-overs. The inline-slitting process can be carried out either with or without bleed trims.

## Fully integrated roll and shaft handling

The finished roll and the winding shaft are transported onto a moveable lifting table by an overhead robot, which pulls the slit rolls from the clamped shaft.

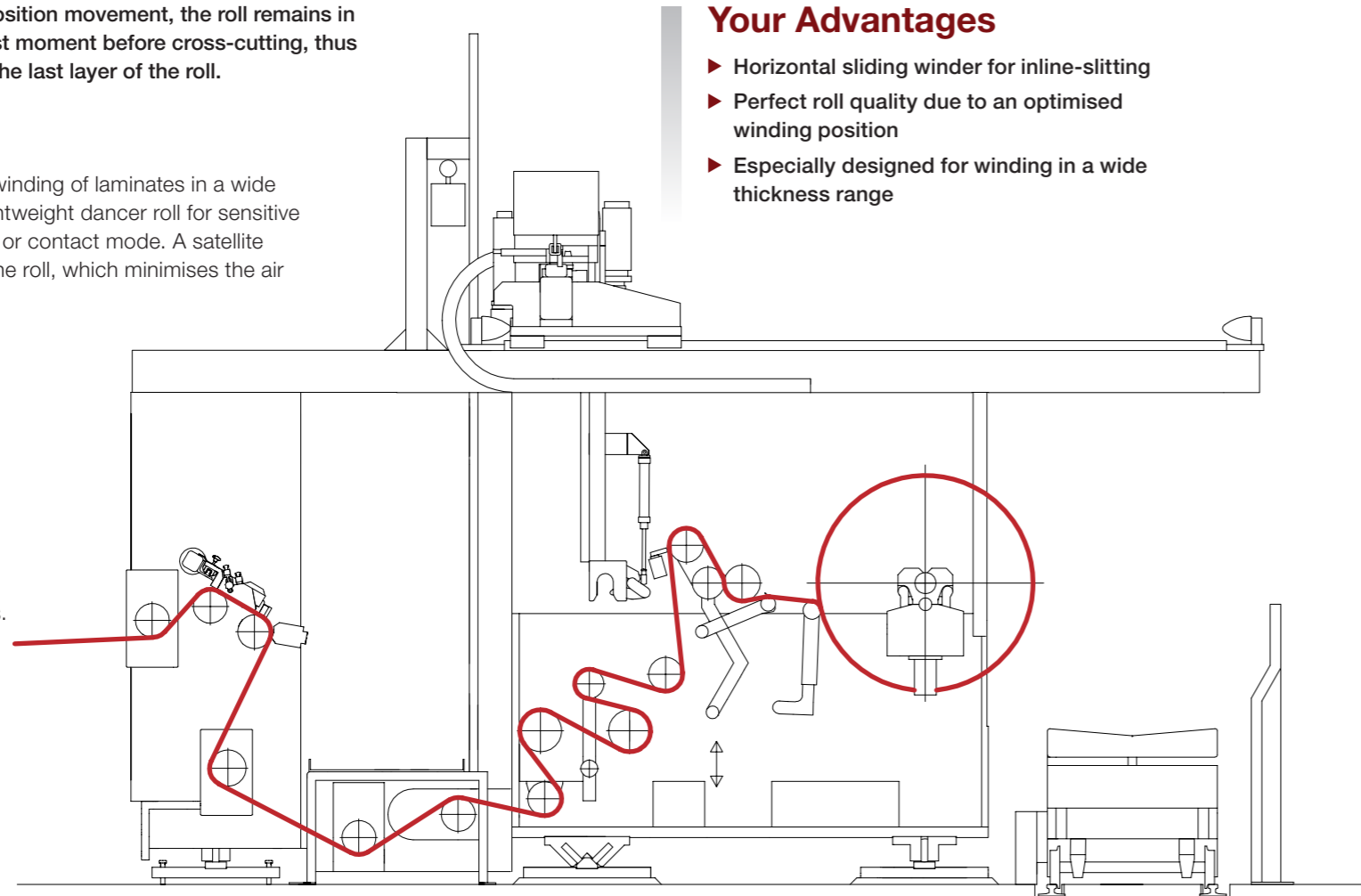

## Your Advantages

- ▶ Horizontal sliding winder for inline-slitting
- ▶ Perfect roll quality due to an optimised winding position
- ▶ Especially designed for winding in a wide thickness range







# FlexPack®

Unconventional thinking is part of our tradition

FlexPack® stands out as a compact and modular laminating line for a **wide range of applications** – ranging from flexible packaging to textiles, and from construction to automotive products.

The market and thus the requirements for extrusion lines are constantly changing. SML keeps up with the times and FlexPack® is the best proof of this.

FlexPack® guarantees thoroughly safe, cost-effective and user-friendly production while delivering extraordinary product qualities. Its modular set-up facilitates the subsequent positioning of a second laminator, creating highly complex laminate structures in one single production step.



## Unexpected location of the unwinder

The unwinder is located on the 1<sup>st</sup> floor to shorten the required line space and the reels have to be lifted up with a crane. However, the success of our customers shows that the extra effort pays off in the long term. This way, our clients can observe every line path and immediately identify any defects.

## Processing various types of products

SML's FlexPack® lines are typically equipped with automatic turret unwinder and a turret rewind as a standard. They facilitate the processing of various products that contain substrates such as paper, film, aluminium foil, nonwovens and others.

## Creating a customised experience

At SML, we hardly shy away from new ideas. Thanks to our FlexPack® demonstration line in our Technology Centre at our headquarters in Austria, we are very flexible and can check special requests for their feasibility. The modular FlexPack® concept specifically allows a high degree of customisation to meet the most specific requirements. It even makes retrofitting possible if a different product is required.

## Intuitive machine operation

FlexPack®'s coherent line concept is completed by SML's comprehensive control system SMILE. Developed entirely in-house, SMILE precisely manages the interaction among each of FlexPack®'s modules, enabling the smooth processing a host of different materials while considerably boosting the overall performance of the whole line.

## FlexPack® – the modular line concept for different configurations

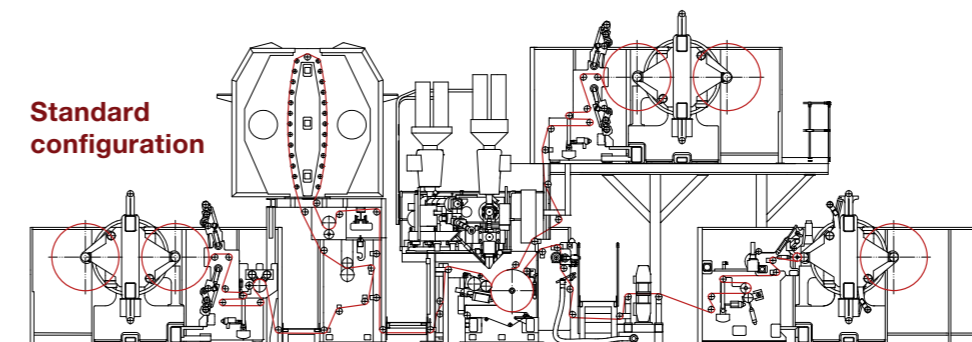
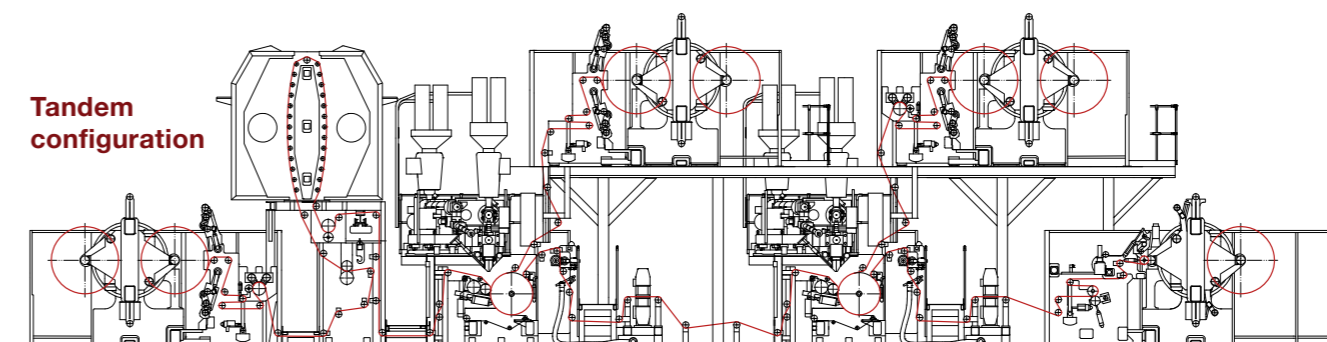

|                           |   |
|---------------------------|---|
| <b>Substrates</b>         | BOPP, BOPET, paper, aluminium foil, metallised film, barrier film, nonwoven, etc. |
| <b>Products</b>           | flexible packaging, technical applications  |
| <b>Substrate width</b>    | <b>FlexPack® 1500</b> 700 – 1,350 mm<br><b>FlexPack® 1800</b> 800 – 1,650 mm      |
| <b>Extrusion material</b> | LDPE, PP, EAA, EMA, EVA, ionomers ...   |
| <b>Coating weight</b>     | 9 - 50 g/sqm (depending on the product)   |
| <b>Coating layers</b>     | 3-layer (optional 5-layer)  |
| <b>Maximal line speed</b> | 350 m/min winding shafts;<br>450 m/min shaftless                                  |

## Your Advantages

- ▶ Wide application area – from flexible packaging to applications in the technical sector
- ▶ Modular and compact line set-up
- ▶ Excellent price/performance ratio

### Unwinding equipment

FlexPack®'s fully automatic turret unwinder offer automatic splicing at full operating speed, for constant production conditions. An optional constant gap device is provided for highly sensitive substrates, such as aluminium foils, allowing a smooth peel-off from the roll.

### Coating unit

- ▶ Chill roll, Ø 800 mm
- ▶ Rubberised pressing roll, Ø 200 mm
- ▶ Steel supporting roll, Ø 250 mm
- ▶ Quick-change equipment for each roll
- ▶ Adjustable stripper roll at the chill roll outlet
- ▶ Adjustable PTFE belt attachment for overcoating

### Thickness measuring system

Frame with Beta sensor for maximum product flexibility. Additional frames for differential thickness measuring as an option.

### Edge trim handling

- ▶ Shear cut system with circular knives and a driven counter-knife, mounted at the exit of the coating unit.
- ▶ Edge trim suction system with a blower, a Venturi system, a pre-cutter and a sound absorber
- ▶ Edge trim can either be collected in a big bag or container or passed to a compactor.

### Winders

For its FlexPack® lines, SML offers the winders W1500 WS or W1500 SL. These are fully automatic turret winders with a roll change at full operating speed for constant production conditions.

### Corona treatment

A driven, ceramic treatment roll is equipped with a rubberised pressing roll for web tension control. Ceramic electrodes are available for the treatment of conductive and non-conductive substrates.

### Primer coating

To increase adhesion, SML offers a gravure roll system with a chamber doctor blade for anchor-coating, when co-extrusion is not sufficient. The vertical dryer has movable hoods for a minimum space requirement. A driven fixpoint roll with a rubberised pressing roll offers exact web tension control. As an option the fixpoint roll can be water-cooled.

### Extrusion

Extruder carriage with a floor level track-system, motorised 3-axis movement and an adjustable die oscillation function.

- ▶ Gravimetric batch dosing system with 4 components (optional 6 components)
- ▶ Main extruder: Ø 90/33 L/D
- ▶ Side extruder: Ø 60/33 L/D
- ▶ Specially designed screws are installed for the polymers used in coating applications
- ▶ An advanced heating system on the barrel reduces the energy consumption

### Tool unit, feedback and flat die

Compact housing with a piston-type manual filter and an integrated manual melt pressure regulation valve.

- ▶ 3-layer feedback with variable geometry
- ▶ T-die with manual or automatic die bolt adjustment
- ▶ EBR-deckling system (adjustable internal and external deckling)
- ▶ Removable die splitter for easy die cleaning
- ▶ Fume exhaust

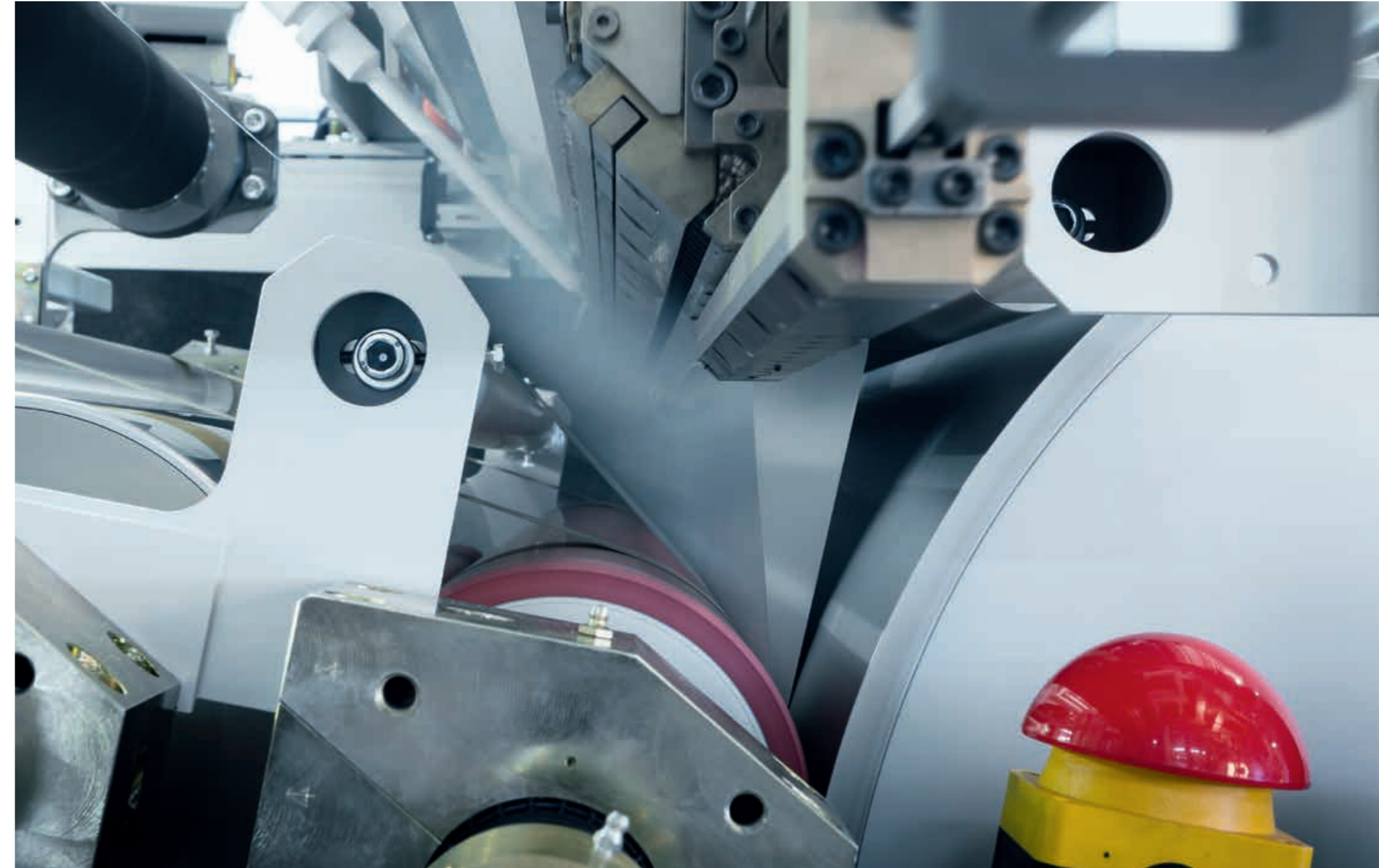



# Triplex

The supreme discipline of extrusion lamination

Triplex is designed to produce **complex composite carton packaging** in one simple **and cost-effective process**. The application areas range from classical liquid beverage cartons to pouches.



Packaging for beverages extracted from natural food sources such as fruit juice present a particular challenge in the engineering of systems and processes. This sector demands durable machines, robust mechanical engineering and precise machine control.

## Processing thin paper and paperboard

The Triplex extrusion lamination line strikes a reasonable balance between very sensitive and fast-responding tension control in low tension areas and a robust, long-lasting design for materials like rigid cardboard. In contrast to most other lines in this market segment, SML's Triplex line processes paper as well as rigid paperboard with the same high quality. There is also the option of modulating the line to run without aluminum or with substitutions.

## Precisely controlled processes

The standout technical attribute of the Triplex line is the precise interaction between different machine units, managed by SML's developed central machine control system, SMILE. The sensitive tension control communicates between the different PLCs, drives and measuring cells within microseconds and is one of the best examples of SML's skills in this field.

## Ready for heavy loads

The general line set-up of the Triplex extrusion lamination line makes the waste-free changes of materials easy and fast. SML's fully automatic drum winder, W1800, is fitted with an automatic reel and shaft handling system. It supports the winding of heavy product rolls of up to 4 tons.

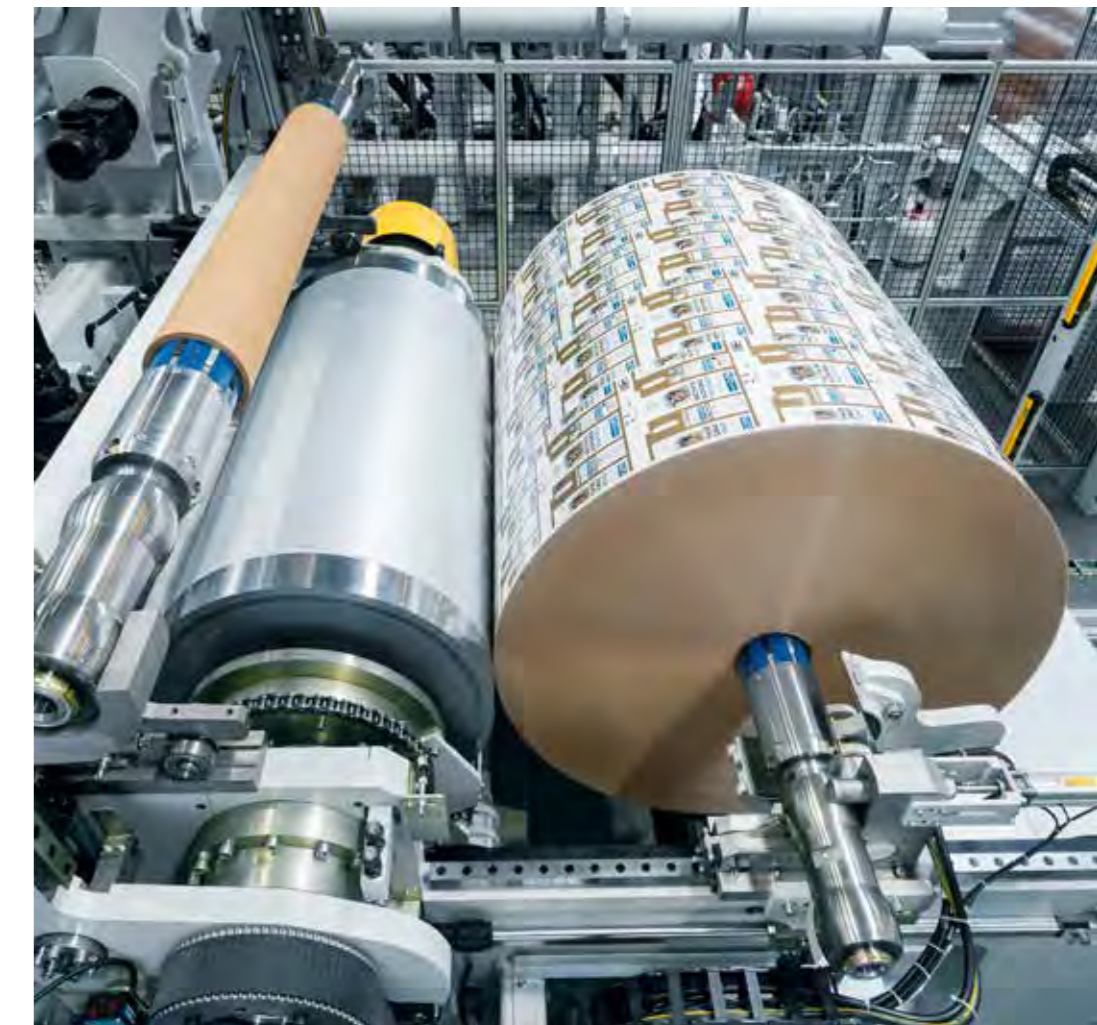

## Your Advantages

- ▶ Production of aseptic board laminates of a high quality
- ▶ Optimised product change over - low waste
- ▶ Durable machine design and comfortable operation



# DoubleCoat

Joining of seemingly incompatible materials

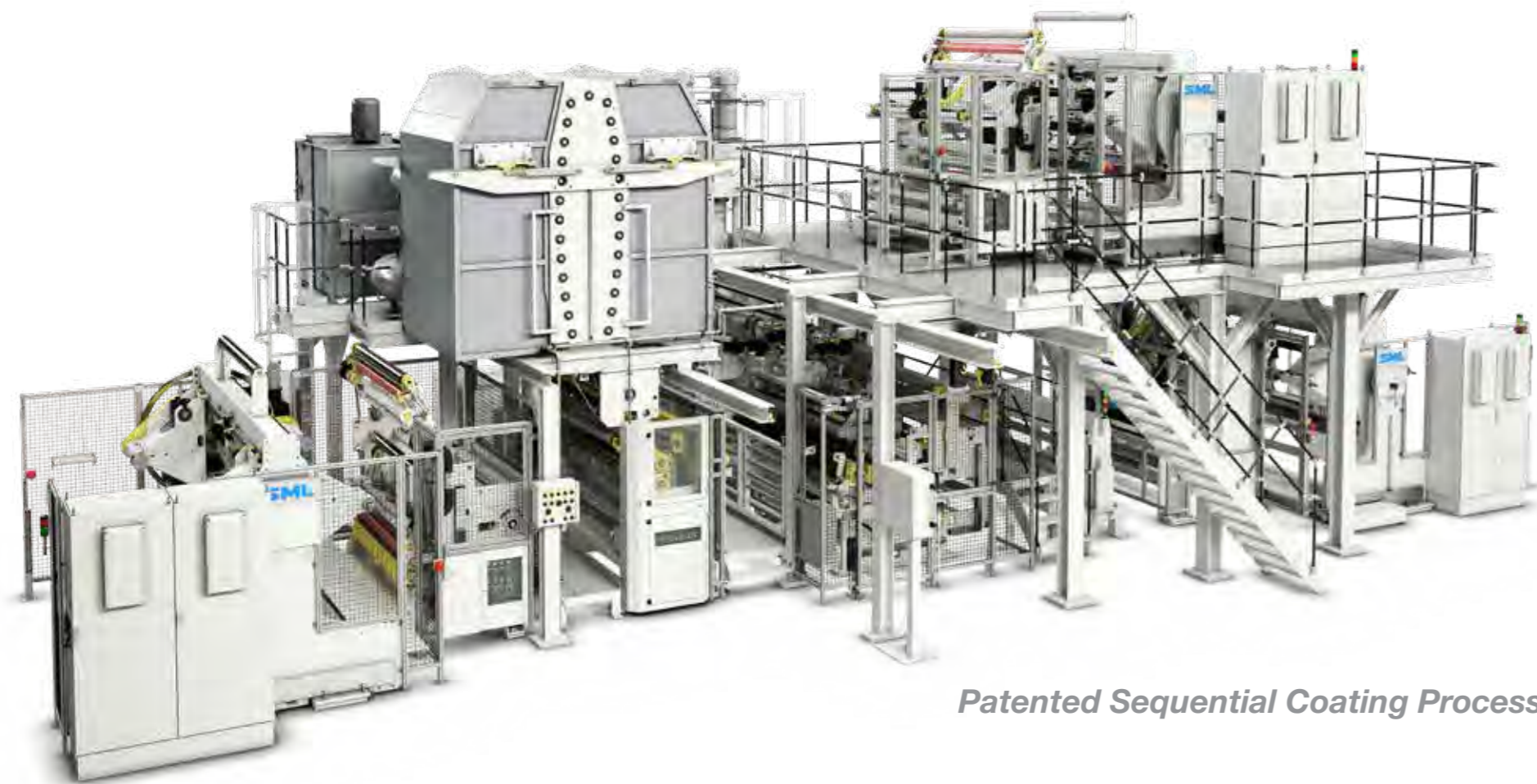

Patented Sequential Coating Process

DoubleCoat is SML's **patented concept** for the production of **extremely thin, breathable products** with outstanding properties.

Application areas up to now, are sanitary articles, functional clothing and products for the construction industry.

DoubleCoat combines extrusion coating with hot melt lamination. In this way materials considered to be incompatible can be joined, for example a TPU or TPE coating layer on PP nonwoven spunbonds. A good match between the substrate, adhesive and extruded membrane is the basis for the creation of products with unequalled features.

## The advantages of the “doublecoat” process at a glance

- ▶ Reduced coating layer thickness
- ▶ Material savings and hence lower costs
- ▶ Strong adhesion
- ▶ Improved breathability
- ▶ High water column
- ▶ Enhanced mechanical properties

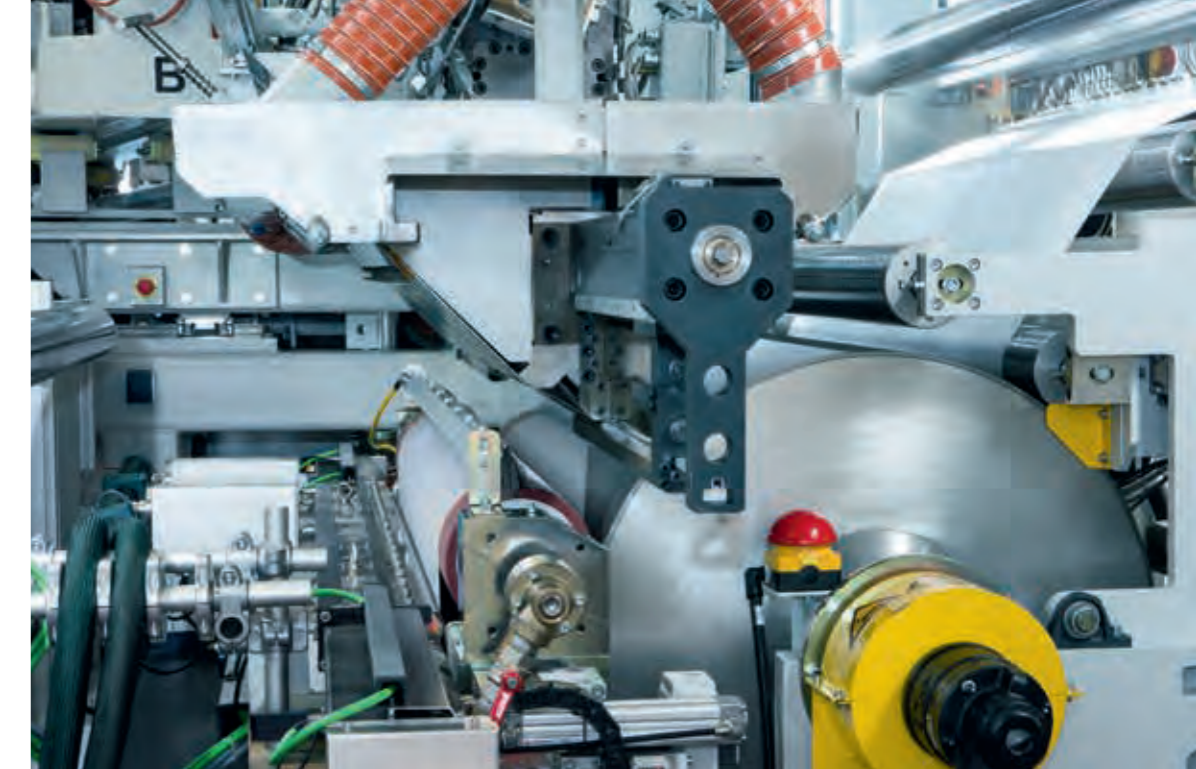

## Minimised coating thickness

The new method has considerable effects on the thickness of coatings. For TPE on a PP nonwoven, a minimum coating layer thickness of down to 7 µm can be achieved. This corresponds with roughly a mere quarter of the current average for such coatings. An excellent product quality is guaranteed, as the thin coating layer's adhesion to the substrate is perfect and no pinholes occur.

## Increased product breathability

Enhanced breathability is a central feature of SML's DoubleCoat technology, as the coating thickness has a significant effect on the water vapour transmission rate (WVTR).

## Your Advantages

- ▶ Ultra thin coating layers
- ▶ Improved breathability
- ▶ Optimised adhesion between different substrates



# Extra wide

## Extrusion coating and laminating line



Every line a unique customised solution



The coating of wide products has been one of the core competencies of SML for decades. One characteristic all these lines have in common is a **very massive machine frame** to withstand the high web tensions and **to avoid vibrations.**

Because the specifications for extra wide lines are usually quite unique, extra wide coating and laminating lines are completely customised. No installation is like the other. When it comes to automation, the team at SML is always able to implement the most complex interfaces.

### A long-term investment

Wide lines have already been successfully installed for a variety of applications such as products for landfills, greenhouses, sun-shades as well as tarpaulins and reel-wraps. The best part: High-quality systems manufactured by SML are still producing flawlessly after more than 30 years.

### Unwinding

For these types of machines, SML can provide either fully automatic turret unwinder for roll changes up to the full operating speed, or semi-automatic double unwinds.

### Substrate treatment

Possible treatment methods are corona treatment or flame treatment. Since substrates, such as woven fabrics, are often wet and contaminated with dust, they need to be cleaned or even dried before further processing.

### Extrusion

SML provides high-performance extruders to run at the optimum production speed. For special applications, SML also offers solutions with twin-screw extruders. SML favours hanging extruder arrangements to accommodate wide flat dies, as their stability is much higher.

### Coating unit

The wider a line gets, the more effort needs to be invested to avoid the bending of the rolls. SML's wide lines are usually fitted with big diameter rolls in combination with calculated bending compensation to achieve a constant pressing nip over the whole product width.

### Winders

Winders for extra wide lines need to be able to handle rolls with big diameters and several tons of weight. SML typically offers drum winders for these types of applications. Inline-slitting for part bobbins is available as an option.

## Your Advantages

- ▶ Massive machine frame to withstand high web tensions
- ▶ Well-proven for a wide range of different applications
- ▶ Tailor-made machine configurations



# Process Combinations and Integrations

**SML offers combined machines** for all major flat die extrusion processes, such as cast film, sheet calendering and extrusion coating.



It is a logical step to combine the substantial know-how derived from these different operations to build up integrated production lines.

Individual substrates, which are required in a laminated structure are often produced using the cast or calendering method. In order to optimise product quality and to save production costs, in some cases the fabrication of the substrate and the lamination process can be merged in one single extrusion lamination line.

Typical examples of this type of combination include production lines for asymmetric PA/PE barrier films and inline PET/PE lamination for sealable PET-trays.

## Your Advantages

- ▶ Cutting production costs
- ▶ Streamlining manufacturing processes
- ▶ Integration with machinery from external manufacturers

## Outstanding end-to-end service support. Reliable assistance – around the globe, at all times.

### Always at your disposal.

Our dedicated customer service team offers reliable assistance to ensure the continuous operation of any SML extrusion line at all times. Regardless of how long a system has been in operation, we offer service to every customer.

- ▶ Long term experienced SML service technicians
- ▶ Support in all ways – via telephone, video call, chat, email and in person
- ▶ On-call service from 7 am to 10 pm CET
- ▶ Remote maintenance system
- ▶ Visual assistance via smart glasses as an option
- ▶ SML service technicians on call worldwide
- ▶ Quick on-site service

### Immediate assistance.

The remote maintenance system, which is available for every SML extrusion line, makes it easier to identify potential problems and provide a quick diagnosis. In order to find solutions, our service team works closely together with other departments at SML. This way, 85 – 90 % of all malfunctions can be solved remotely.



**Our highly-skilled technicians are at your service within 24 hours throughout Europe and within 48 hours in the rest of the world.**

### Up-to-date knowledge and experience.

Our service team consists of technicians who know SML's extrusion lines inside out, having installed them themselves for many years. In order to keep their know-how up to date, all service employees continue to work regularly in everyday production. Their competence is reflected in the short reaction times to our customers' enquiries.

### Visual assistance in real time.

Through the use of smart glasses, our service team can provide real-time assistance worldwide. Whether our customers have technical problems, need help with product changes or maintenance work - they are guided step by step. This service is available for every extrusion line from SML.

# Proven technology – **new design**

When it comes to line performance, high quality and precise interaction of the internal components are particularly important. But who says **extrusion lines** shouldn't **look great too?**



# Technology that makes you smile

## **SMILE** control system

Not sure if a technology can really make you smile? Now, let the facts about **our ingenious machine** control systems **convince you.**

SMILE is SML's machine control and operation concept, allows the **highly precise synchronisation** of all the components in an **extrusion system**. If an extrusion system is the powerful body, then SMILE is the driving soul that brings that body to life.

### 100 % developed in-house

The dynamic controller system is entirely developed in-house and has undergone significant further development in recent years. SML's long-standing competence in the field of automation and machine control provides loads of innovative and exceptional features.

### Centralised all-in-one concept

SMILE's central control station system allows the management of each production process with a wide touch screen attached to the film line. More than 1000 signals come together here, collected by many sensors, transducers and motors and transported via modern Ethernet bus systems.

This data includes sensory measurements like temperatures, speeds and pressures as well as actuator readings from valves, hydraulics, drives and positions. Thanks to SMILE, all of these components are interconnected and can be perfectly synchronised with each other. This fine-tuning allows customers to run their film lines at the very best performance level.



E-container

### Intuitive machine control

At SML, we believe machine control and operation should be highly intuitive and self-explanatory. SMILE is therefore an integral part of our coherent and user-friendly overall line concept.

- ▶ A central control station system for the highest operating comfort and the visualisation of all processes
- ▶ Reduced training efforts and error rates at operator level
- ▶ Remote control, remote update and remote service (from a PC or even a smartphone)
- ▶ The system is suitable for multiple clients and users, different types of users can log-in simultaneously

### Optimised production efficiency

One key purpose of SMILE is the increase in the Overall Equipment Effectiveness (OEE) through optimised production processes.

- ▶ Optimised use of raw materials, preventing waste
- ▶ Faster start-up of production
- ▶ Minimised times for product change-overs, customisable assistant for product changes

### Systematic quality control

In close interaction with SML's data collection and analysis system bitWise, SMILE is an efficient tool to keep output quality stable and to optimise output properties.

- ▶ Formula recipe system to store production parameters
- ▶ Documentation and detailed reporting of production processes
- ▶ Automatic alarm functions via e-mail or text message for quick debugging

### Interconnectivity and third-party integration

SMILE has many open interfaces that allow the web-based data exchange with third-party machines and systems.

- ▶ Open to interconnecting with systems like Enterprise Resource Planning (ERP), Quality Assurance (QA) or SML's data analysis tool bitWise
- ▶ Based on open standards like HTML5 and OPC-UA, complete end-to-end process control beyond SML extrusion lines

### Tailored to specific requirements

SMILE can be tailor-made to client's specific requirements. This is blazing the trail to new manufacturing concepts as well as delivering product properties.





# Stop guessing, start knowing with bitWise data analytics

With bitWise, SML's customers can **analyse the entire process history** of a coating and laminating line with a **single click**, rather than relying on **current snapshots**.

BitWise incorporates decades of experience in automation with the **latest technologies in data analytics** and provides for a wide range of **completely new opportunities** for data-driven decisions.

## In-depth view of all details

SML's coating and laminating lines are equipped with hundreds of data-generating sensors. BitWise records and visualises this data up to 10 times per second. In addition, each manufactured roll is provided with a QR code that can be identified again. Putting everything together, manufacturers get an in-depth view of all the details involved in a production process – both in the present and in the past.

With bitWise, customers can look back at pressures within the system components and check whether there is a correlation with other measured values such as the temperature or with the laboratory results of a finished product roll.

## Always connected, even on the go

BitWise is a 100 % on-premises-solution. This means that the data remains in-house on dedicated hardware, no cloud services are required. Nevertheless, customers can access BitWise in their company network via their VPN or a remote desktop solution.



## Optimising quality

BitWise is a powerful tool to precisely optimise any aspect of the production process with a direct effect on product quality.

- ▶ Monitoring of all quality-related process parameters, allowing quick corrective action
- ▶ Comprehensive tracking and documenting of product quality
- ▶ Making quality reproducible

## Maximising output

Recorded, aggregated and visualised data by bitWise helps to raise overall line utilisation and delivers a faster return on investment (ROI).

- ▶ Discovering hidden or unused output capacities
- ▶ Preventing downtimes by detecting potential problems at an early stage
- ▶ Minimising maintenance times through the optimised scheduling and structured access to documentation and service support

## Minimising production costs

BitWise is the central tool to measure and visualise all production related costs. It forms a strong and reliable basis for the continuous cost-optimisation.

- ▶ Detailed monitoring and reporting of energy and raw material consumption
- ▶ In-depth optimising, tracking and reporting of Overall Equipment Effectiveness (OEE)
- ▶ Full end-to-end cost transparency through third-party integration

## Open for vertical integration

At SML we understand that extrusion coating and laminating lines represent a key part in a wider production chain. For end-to-end optimisation, bitWise therefore supports data exchange and vertical integration with third-party systems such as Manufacturing Execution Systems (MES), Enterprise Resource Planning (ERP) or Quality Assurance (QA). Customers can simply retrieve the data from the system.

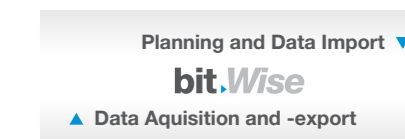

## Choose your perfect interface

As with most technologies developed by SML, bitWise is highly customisable. The remote system can be retrofitted to all existing SML extrusion coating and laminating lines.



Analyses  
Development  
Pre-tested Performance  
Delivery on Time  
Service Support  
Customer Satisfaction

► **SML - Machinery Far East Sdn Bhd**  
(1029958-P)

1201 Block B, Menara Amcorp  
No.18 Jalan Persiaran Barat  
46050 Petaling Jaya  
Selangor Darul Ehsan,  
Selangor, Malaysia  
Phone: +60 3 7955 9098  
Fax: +60 3 7955 9981  
E-mail: yen@sml.at

► **SML - Moscow Office**

Ogorodny proezd, 5  
Building 3, office 408  
127254 Moscow  
Russia  
Phone: +7 495 618 8007  
Fax: +7 495 619 5961  
E-mail: kna@sml.at

► **SML - Beijing Office**

Unit 1410, Landmark Tower  
No. 8 North Dongsanhuan Road  
Chaoyang District  
100004 Beijing, P.R. of China  
Phone: +86 10 6590 0946  
Fax: +86 10 6590 0949  
E-mail: sml@sml.bj.cn

► **SML - North America Service Inc.**

Suite 204  
85 Eastern Avenue  
Gloucester MA 01930  
USA  
Phone: + 1 978 281 0560  
E-mail: jom@sml.at



[www.sml.at](http://www.sml.at)

The image shows a large, modern industrial building with a white facade. The SML logo is prominently displayed on the upper part of the building, rendered in a light blue, three-dimensional font. The building has a long, low profile with a glass-enclosed upper section. In the background, another building with a grid-like facade is visible under a clear sky.

**SML**

► **SML - Head Office**

SML Maschinengesellschaft mbH  
Gewerbepark Ost 32  
4846 Redlham, Austria  
Phone: +43 7673 90999 0  
E-mail: [sml@sml.at](mailto:sml@sml.at)  
[www.sml.at](http://www.sml.at)

**Follow Your Instinct –  
choose SML!**