



100%  
eXtrusion  
CAST FILM LINES

STRETCH WRAP

## LINES FOR STRETCH WRAP



Stretch wrap film lines from SML are characterised by their innovative detail engineering and the constant development of new core components such as high-speed extruders and new types of winders.

In interaction with SML's large-diameter chill rolls, these components considerably contribute to excellent film qualities as well as to SML's position as the accepted market and technology leader in this competitive segment.

SML is covering stretch wrap film lines of all sizes, offering **attractive standard solutions** in widths from 3 - 12up (1,500mm to 6,000mm), as well as **customised lines based on these concepts**. Components like triple chamber vacuum boxes, film temperature measurement (FTM) and K-AP technology are integrated in the lines.

With regard to SML's winding technology, features such as **inline winding on 2-inch cores for hand stretch, coreless and shaftless** winding systems, or thin core technology are all available, together with a diversity of numbers of layers and structures. An additional device for the modification of edges allows the customer to upgrade the machines for light-weight handrolls with enforced and indestructible edges.

Stretch wrap film lines from SML are highly efficient and comfortable to control. The proven SMILE control system and different grades of automation, in terms of roll and core handling, enable customers to operate SML lines with a minimum of manpower. SML's data generation and analysing tool, bitWise, supports the constant optimisation of production processes and final products.

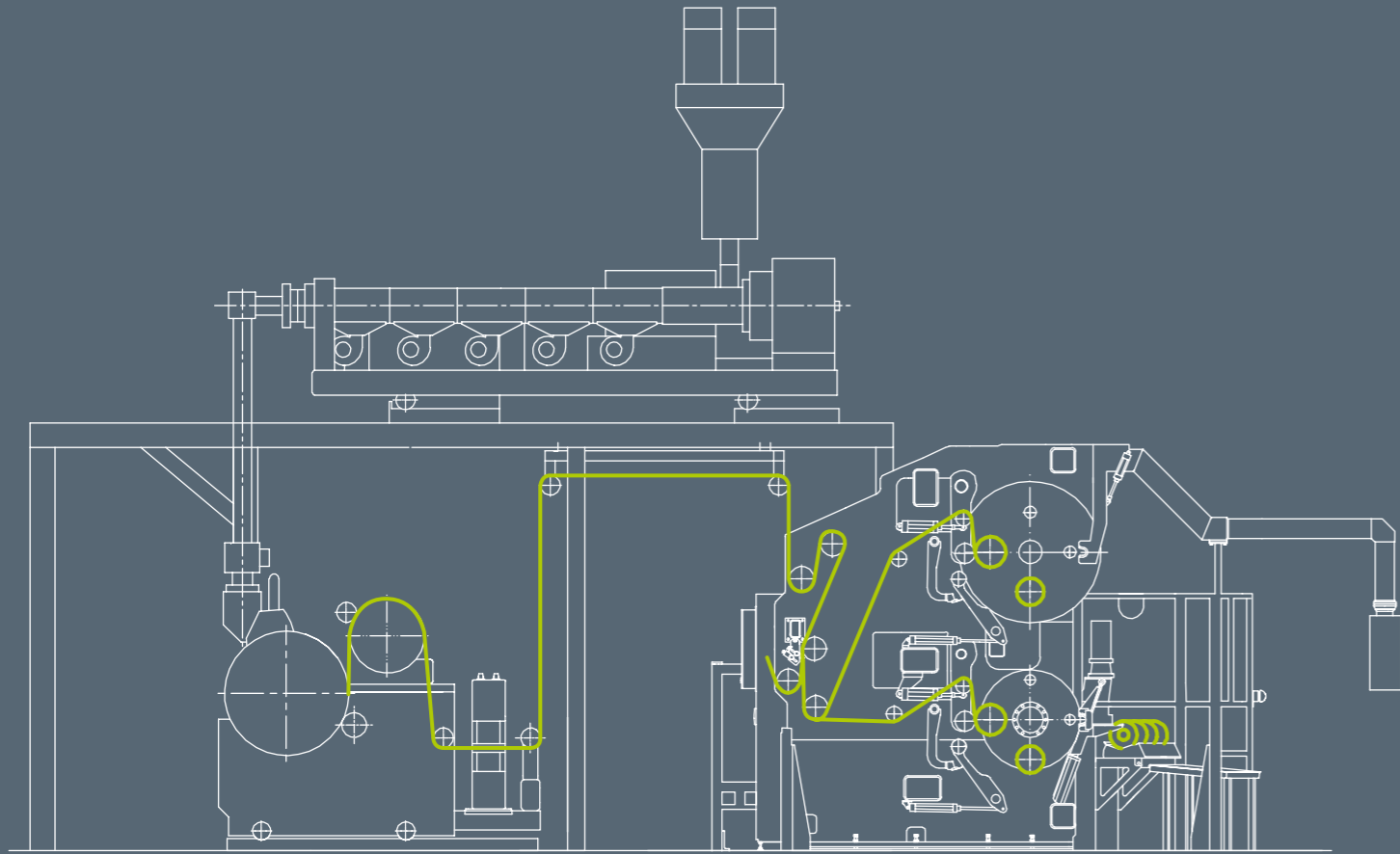

# LINES FOR STRETCH WRAP

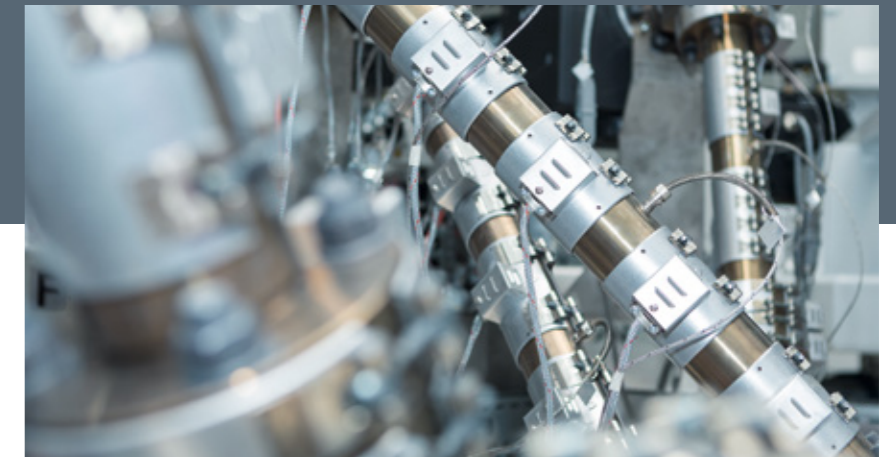

CONTENTS

- MiniCast®** ..... 6
- EcoCompact®** ..... 8
- SmartCast®** ..... 10
- PowerCast** ..... 12
- MasterCast®** ..... 14
- Line Description ..... 16
- Extrusion Unit ..... 19
- Downstream Equipment ..... 23
- Winding Systems ..... 25



# MiniCast®

## Stretch Film Extrusion Line

SML's *MiniCast®* line is the ideal solution for an efficient stretch film production in the smallest spaces.

On a minimum floor area of less than 100sqm, the *MiniCast®* stretch film line can be equipped with up to four extruders, which facilitate a combined extrusion throughput of 1,050 kg/h. *MiniCast®* stretch film lines are pre-manufactured in lots and are therefore available within short delivery times.

### SINGLE ROLL CASTING STATION

The machine incorporates a single roll casting station with a chill roll diameter of 1,200 or 1,600mm and an optical thickness measuring system for translucent films, or an X-ray version for opaque films. Customers can select between edge trim re-feeding via a scraptruder for fluff, or a re-pelletising system.

### WINDING OF HAND, MACHINE AND JUMBO ROLLS

With a single turret version of the well-known W4000-4S winder, the *MiniCast®* stretch film line guarantees top quality winding of hand rolls on 2-inch cores, as well as machine and jumbo rolls on 3-inch cores.

### CHILL ROLL UNIT

- Chill roll Ø 1,200mm or 1,600mm, width 2,100mm
- Optical thickness measurement
- Alternative: X-ray or beta sensor
- Oscillating frame

### EDGE TRIM RE-FEEDING SYSTEM

Vertical scraptruder (fluff re-feeding system). Alternative: recycling unit with reel feeder for the pelletising of edge trim and start-up rolls.

### WINDER

Depending on the customer's requirements, the winders W4000-2S or W4000-4S can be integrated in the *MiniCast®* line.

### TECHNICAL DATA

Products	super power stretch, machine stretch, hand stretch, cling film	
Film thickness range	8 - 50µm	
Film final width	3 x 500mm	
Film structure	3 or 5 layers	
Production speed	up to 650 m/min	
Net output value	12µm	600 kg/h
	17µm	845 kg/h
	23µm / <i>MiniCast®</i> 3L	900 kg/h
	23µm / <i>MiniCast®</i> 5L	1,050 kg/h

<i>MiniCast®</i> 3L
Slip layer
Core layer
Cling layer

<i>MiniCast®</i> 5L
Slip layer
Sandwich layer
Core layer
Sandwich layer
Cling layer

### LINE CONFIGURATION

<i>MiniCast®</i> 3L	<i>MiniCast®</i> 5L
Gravimetric batch dosing system with 2 components. Option: 3 or 4 components	
3 extruders	4 extruders
1 x 90/33 800 kg/h	1 x 90/33 800 / 900 kg/h
2 x 60/28 2 x 200 kg/h	3 x 60/28 3 x 200 kg/h
SML advanced heaters for the extruder barrels	
3-layer feedblock	5-layer feedblock
Automatic flat die: 2,050mm	

## Your Advantages

- ✓ Less than 100sqm floorspace
- ✓ High flexibility and ease of use
- ✓ Short-notice availability

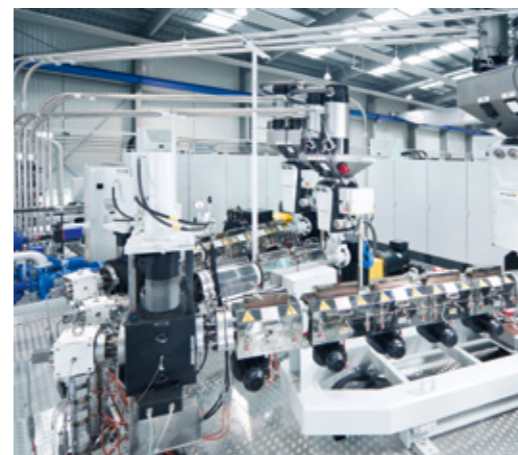

**TECHNICAL DATA**

Products	super power stretch, machine stretch, hand stretch, cling film	
Film thickness range	8 - 50µm	
Film final width	4 x 500mm	
Film structure	3, 5 or 7 layers	
Production speed	up to 650 m/min	
Net output value	12µm	800 kg/h
	17µm	1,125 kg/h
	23µm	1,200 kg/h

<b>EcoCompact® 3L</b>
Slip layer
Core layer
Cling layer

<b>EcoCompact® 5L</b>
Slip layer
Sandwich layer
Core layer
Sandwich layer
Cling layer

**LINE CONFIGURATION**

<b>EcoCompact® 3L</b>	<b>EcoCompact® 5L</b>
Gravimetric batch dosing system with 2 components. Option: 3 or 4 components	
3 extruders	4 extruders
1 x HSE 90/33 950 kg/h	2 x 90/33 each 600 kg/h
1 x 75/33 480 kg/h	2 x 60/28 each 190 kg/h
1 x 60/28 190 kg/h	
SML advanced heaters for extruder barrel	
3-layer feedblock	5-layer feedblock
Automatic flat die 2,550mm	

# EcoCompact®

## Stretch Film Extrusion Line

The *EcoCompact®* line is a standard model in SML's portfolio for stretch film production in 2m-width (4-up) with extruder outputs of up to 1,600 kg/h.

The *EcoCompact®* has a small footprint of only 140sqm, including a recycling system.

**MAXIMUM FLEXIBILITY**

For many customers, the *EcoCompact®* line represents the ticket to top quality stretch film production. While for others, as compared to their larger production lines, it is simply the most flexible line with regard to product changes.

**VERSIONS WITH THREE, FIVE OR SEVEN LAYERS**

As a rule, SML delivers the *EcoCompact®* in a three, a five and a seven layer version. And as far as winding technology is concerned, all three of SML's stretch film winders can be integrated in the line in order to achieve the best and most cost-efficient solution.

**CHILL ROLL UNIT**

- Primary chill roll Ø 1,200mm or 1,600mm, width 2,700mm
- Optional secondary chill roll Ø 400mm, width 2,700mm
- IR thickness measurement
- Alternative: X-ray or beta sensor
- Oscillating frame
- Cut-resistant guiding rolls

**EDGE TRIM RE-FEEDING SYSTEM**

Recycling unit with reel feeder for the pelletising of edge trims and start-up rolls.  
Alternative: Vertical scraptruder (fluff re-feeding system)

**WINDER**

Depending on the customer's requirements, the winder W4000-2S, the winder W4000-4S and also the winder W3000-4S can be integrated in the *EcoCompact®* line.

## Your Advantages

- ✓ Stretch film production in 2m-width (4-up)
- ✓ Maximum flexibility for fast production changes
- ✓ Highest film qualities with a small footprint



# SmartCast®

## Stretch Film Extrusion Line

The name *SmartCast*® stands for SML's 3m-wide (6-up) machine concept for the production of enhanced stretch film qualities at a top performance level.

### EASY CUSTOMISABLE

A modular system consisting of four pre-configured extrusion units with throughputs ranging from 1,900 kg/h to 3,000 kg/h and a choice between five or seven layers, guarantees easy customising to meet individual requirements.

### PRODUCTION SPEEDS UP TO 750 M/MIN

Using the optional edge encapsulation system, production speeds of up to 750 m/min are feasible. This provides an output on the winder of over 1,400 kg/h of 12µm film.

### VIBRATION-FREE CHILL ROLL UNIT

Apart from a new generation of standard and high-speed extruders, SML has also upgraded the chill roll unit by adding additional functions, avoiding vibrations and making operation easier.

### CHILL ROLL UNIT

- Primary chill roll Ø 1,200mm or 1,600mm, width 3,800mm
- Optional secondary chill roll Ø 400mm, width 3,800mm
- Automatic positioning
- IR thickness measurement
- Alternative: X-ray or beta sensor
- Oscillating frame
- Cut-resistant guiding rolls

### EDGE TRIM RE-FEEDING SYSTEM

Recycling unit with reel feeder for the pelletising of edge trims and start-up rolls.  
Alternative: Vertical scraptruder (fluff re-feeding system).

### WINDER

Depending on the customer's requirements, the winder W4000-2S, the winder W4000-4S and also the winder W3000-4S can be integrated in the *SmartCast*® line.

### TECHNICAL DATA

Products	super power stretch, machine stretch, hand stretch, cling film	
Film thickness range	8 - 50µm	
Film final width	6 x 500mm	
Film structure	5 or 7 layers	
Production speed	up to 750 m/min	
Net output value: <i>SmartCast</i> ® XL	12µm	1,400 kg/h
	17µm	2,000 kg/h
	23µm	2,400 kg/h

<i>SmartCast</i> ® 5L
Slip layer
Sandwich layer
Core layer
Sandwich layer
Cling layer

<i>SmartCast</i> ® 7L
Slip layer
Side layer
Sandwich layer
Core layer
Sandwich layer
Side layer
Cling layer

### LINE CONFIGURATION

<i>SmartCast</i> ® S 5L	<i>SmartCast</i> ® M 7L	<i>SmartCast</i> ® L 5L	<i>SmartCast</i> ® XL 7L
Gravimetric batch dosing system with 2 components. Option: 3 or 4 components			
5 extruders	6 extruders	5 extruders	6 extruders
2 x 90/33 each 600 kg/h	2 x 90/33 each 750 kg/h	2 x HSE 90/33 each 950 kg/h	2 x HSE 90/33 each 950 kg/h
1 x 75/33 480 kg/h	4 x 60/28 each 240 kg/h	1 x 90/33 600 kg/h	4 x 75/33 each 300 kg/h
2 x 60/28 each 240 kg/h		2 x 75/33 each 300 kg/h	
SML advanced heaters for extruder barrel			
Edge encapsulation extruder 45/28D (optional)			Edge encapsulation
5-layer feedblock	7-layer feedblock	5-layer feedblock	7-layer feedblock
Automatic flat die: 3,750mm			

## Your Advantages

- ✓ Modular system with four pre-configured extrusion units
- ✓ Repeatable casting position
- ✓ Ability to switch between 2-inches and 3-inches core diameter winding or coreless winding



# PowerCast

## Stretch Film Extrusion Line

PowerCast represents the latest 4m-wide (8-up) high performance stretch film line which is perfectly suited to the market's needs in terms of quality and quantity.

It stands out for its production flexibility to handle 3-inch hand, machine and jumbo rolls at high production speeds.

### THREE PRE-CONFIGURED EXTRUSION UNITS

PowerCast uses the very last generation of SML's High Performance Extruders (HSE). A standardised system with three pre-configured extrusion units at throughputs ranging from 2,400 kg/h to 4,200 kg/h and the choice between 7 to 67 layers guarantee easy customising to meet individual requirements. In addition to SML's advanced extrusion system, SML's PowerCast line is fitted with a chill roll unit using a 1,600mm diameter C1 roll, guaranteeing a vibration-free and smooth operation.

### WINDING SYSTEM FOR THE HIGHEST FLEXIBILITY

Using the optional edge encapsulation system, production speeds of up to 850 m/min are feasible, which provides an output on the winder of over 2,000 kg/h of 12µm film. The winder W4000-4S allows a quick changeover when a different roll width is needed. It is easy to produce 400/450/500mm, and also 750mm with the XL version, without using a deckling or a winder edge trim.



### CHILL ROLL UNIT

- Primary chill roll Ø 1,600mm, width 5,000mm
- Chill roll Ø 400mm, width 5,000mm
- Automatic positioning
- IR thickness measurement
- Alternative: X-ray or beta sensor
- Oscillating frame
- Cut-resistant guiding rolls

### EDGE TRIM RE-FEEDING SYSTEM

Vertical scraptruder (fluff re-feeding system)  
Alternative: Recycling unit with reel feeder for the pelletising of edge trims and start-up rolls.

### WINDER

Depending on the customer's requirements, the winder W4000-2S or the winder W4000-4S can be integrated in the PowerCast lines.

### TECHNICAL DATA

Products	super power stretch, machine stretch, hand stretch, cling film	
Film thickness range	8 - 50µm	
Film final width	8 x 500mm, 9 x 450mm, 10 x 400mm	
Film structure	7 - 67 layers	
Production speed	up to 850 m/min	
Net output value <b>PowerCast</b>	12µm	>2,000 kg/h
	23µm	3,400 kg/h

<b>PowerCast 7L</b>
Slip layer
Side layer
Sandwich layer
Core layer
Sandwich layer
Side layer
Cling layer

### LINE CONFIGURATION

PowerCast S	PowerCast L	PowerCast XL
Gravimetric batch dosing system with 2 components. Option: 3 or 4 components		
7 extruders	7 extruders	7 extruders
2 x 90/33 each 600 kg/h	2 x 90/33 each 950 kg/h	2 x 90/33 each 950 kg/h
5 x 60/28 each 240 kg/h	5 x 75/33 each 380 kg/h	4 x 75/33 each 450 kg/h
		1 x 90/33 600 kg/h
SML advanced heaters for extruder barrel		
Edge encapsulation extruder 45/28D		
7-layer feedblock (optional 9, 11, 13, 55, 67 layers)		
Automatic flat die: 4,800mm		5,435mm

## Your Advantages

- ✓ 4 meter wide (8-up) standard stretch film line
- ✓ 4,5 meter wide (9-up) XL stretch film line
- ✓ Choice between 7 to 67 layers



# MasterCast®

## Stretch Film Extrusion Line

The manufacture of machine rolls in large quantities with maximum efficiency requires production lines with exceptional output ranges.

### UNREACHED OUTPUT VOLUME

The MasterCast® line from SML is a globally unique system in a width of 6 metres (12-up) and with an installed extrusion capacity of up to 5,000 kg/h. A production line on this scale offers an unbeatable ratio with regard to the investment costs per kg of output, minimised labour costs and optimum energy use.

### FIVE OR SEVEN LAYER VERSION

Equipped with proven SML components, this line is offered in a five and a seven layer version. In combination with the fully automatic triple turret winder W4000, the MasterCast® sets new standards for the mass production of stretch wrap films.



### TECHNICAL DATA

Products:	super power stretch, machine stretch, standard stretch	
Film thickness range:	(8) 10 - 50µm	
Film final width:	12 x 500mm	
Film structure:	5 or 7 layers	
Production speed:	up to 650 m/min	
Net output value:	12µm	2,400 kg/h
	17µm	3,300 kg/h
	23µm	4,000 kg/h

MasterCast® 5L
Slip layer
Sandwich layer
Core layer
Sandwich layer
Cling layer

MasterCast® 7L
Slip layer
Side layer
Sandwich layer
Core layer
Sandwich layer
Side layer
Cling layer

### LINE CONFIGURATION

MasterCast® 5L	MasterCast® 7L
Gravimetric batch dosing system with 2 components. Option: 3 or 4 components	
5 extruders	6 extruders
2 x 150/33 each 1,250 kg/h	2 x 150/33 each 1,250 kg/h
1 x 135/33 1,050 kg/h	4 x 90/33 each 600 kg/h
2 x 90/33 each 600 kg/h	
SML advanced heaters for extruder barrel	
5-layer feedblock	7-layer feedblock
Automatic flat die: 6,950mm	

### CHILL ROLL UNIT

- Primary chill roll Ø 1,200mm or 1,600mm, width 7,000mm
- Secondary chill roll Ø 600mm, width 7,000mm
- IR thickness measurement
- Optional X-ray or beta sensor
- Oscillating frame
- Cut-resistant guiding rolls

### EDGE TRIM RE-FEEDING SYSTEM

Recycling unit with reel feeder for the pelletising of edge trim and start-up rolls. Alternative: Vertical scraptruder (fluff re-feeding system).

### WINDER

Winder W4000

## Your Advantages

- ✓ Unique system in a width of 6 metres (12-up)
- ✓ Extrusion capacity of up to 5,000 kg/h
- ✓ Unbeatable with regard to the investment costs per kg of output



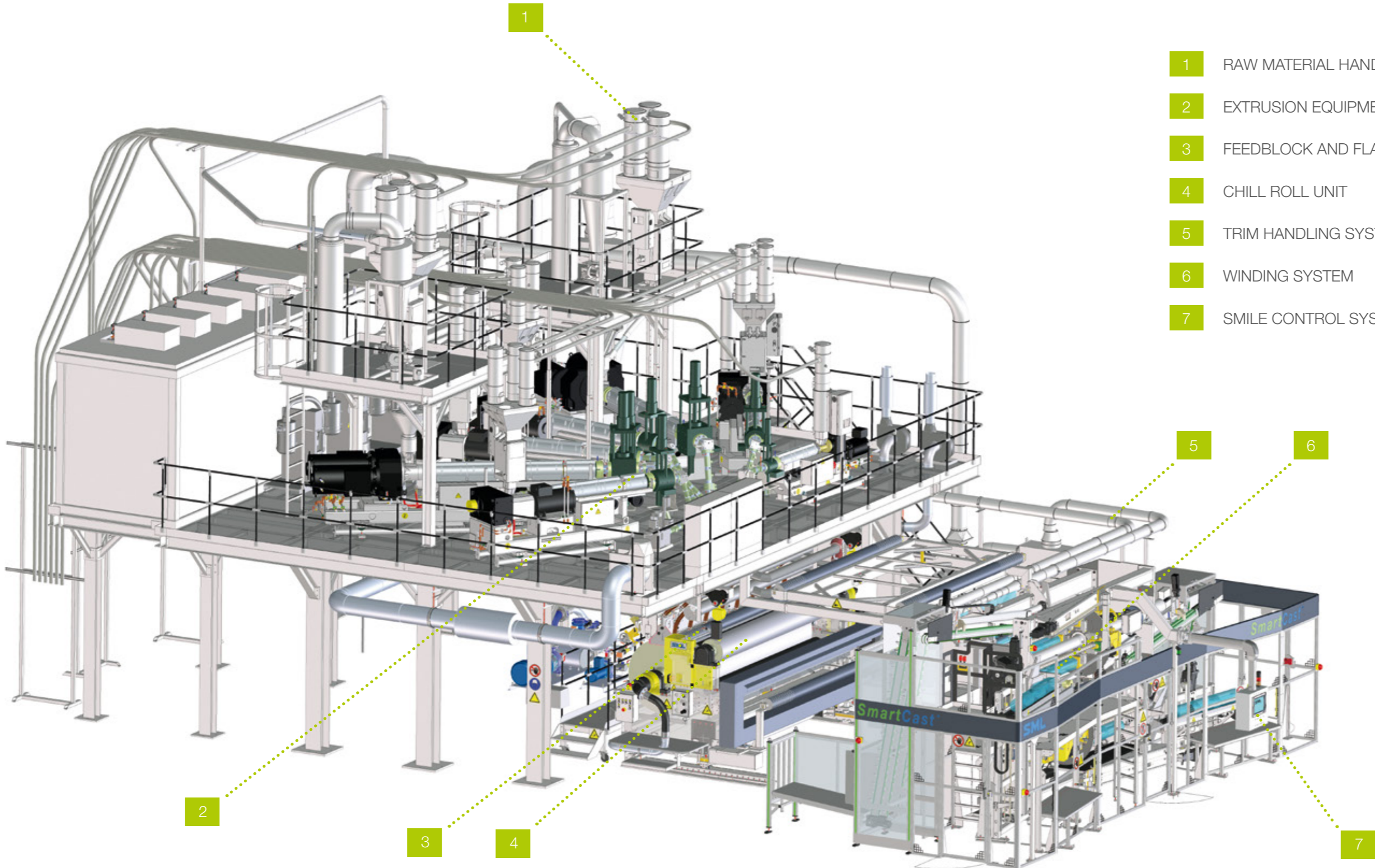

- 1 RAW MATERIAL HANDLING AND DOSING
- 2 EXTRUSION EQUIPMENT
- 3 FEEDBLOCK AND FLAT DIE WITH ENCAPSULATION
- 4 CHILL ROLL UNIT
- 5 TRIM HANDLING SYSTEM
- 6 WINDING SYSTEM
- 7 SMILE CONTROL SYSTEM



DOSING UNIT ▲

## 1 Raw material handling and dosing

SML offers a wide range of gravimetric batch blenders and continuous gravimetric feeders with up to six components per extruder. Applying all of these systems enables recipes to be run with a great accuracy and repeatability.

The complete dosing unit, as well as all the material supply vacuum pumps, filters, and valves are fully integrated in SML's machine control system, SMILE.



Gravimetric batch dosing system



Continuous gravimetric dosing system

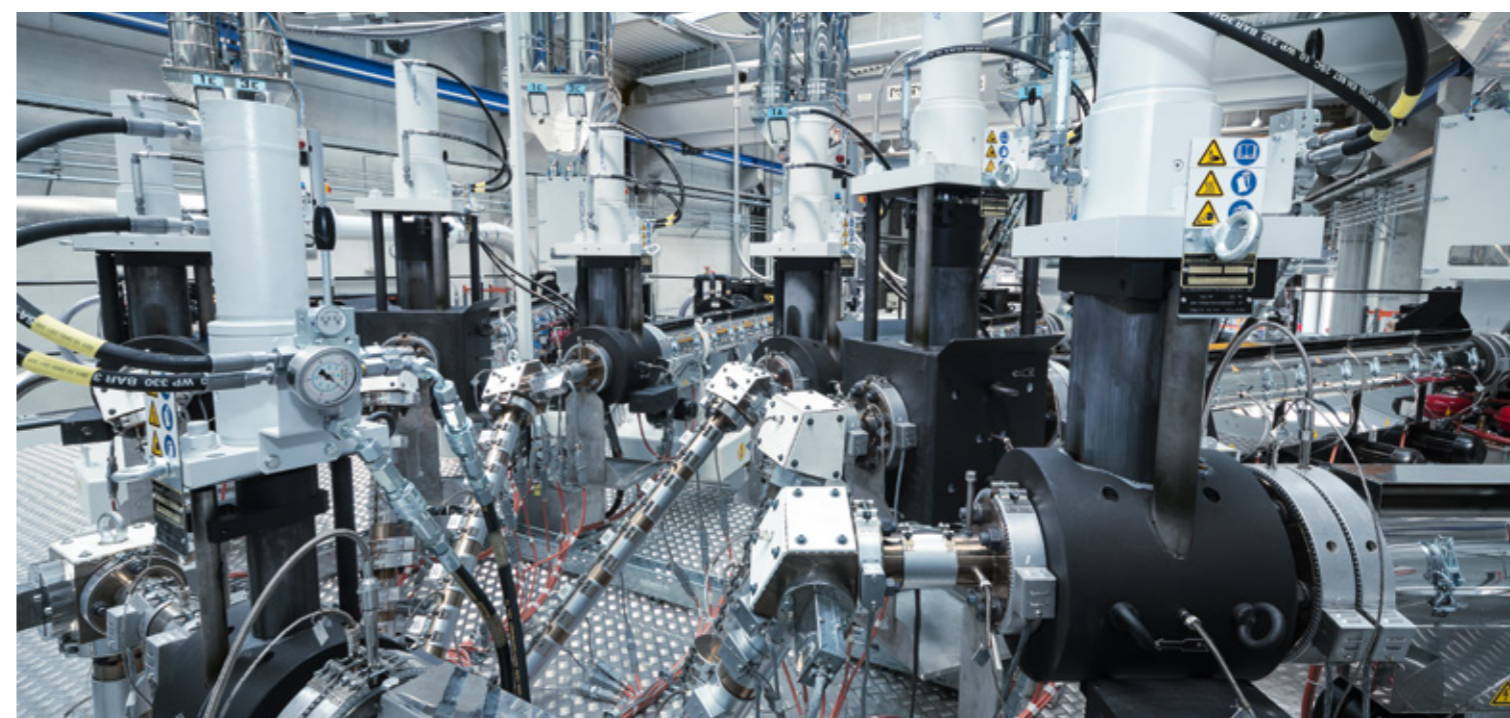

EXTRUSION TOOL UNIT ▲

## 2 Extrusion equipment

All of the SML stretch film extruders are designed to handle a wide range of polymers used in this market. A choice of standard versions with 45 – 180mm screw diameters and a 90mm high-speed version are available. The extruders with an L/D ratio of 28 or 33 and bimetallic barrels are driven by energy efficient, water-cooled AC motors as a standard feature.

### HIGHLY ADVANCED SCREW DESIGN

Although stretch wrap film is regarded as a commodity, the screw design is highly sophisticated. For example, hardened flanks, barrier, shearing and mixing zones are all employed inline with the layer characteristics, such as slip, cling or functional layers and the polymers utilised in the extruder. Today, apart from standard LLDPEs in C4, C6 or C8 quality, an increasing number of mLLDPEs, widely spread MFIs and even other polymers such as PP are being used in stretch film production.

### HEATING SYSTEM WITH GRAVITY-CLOSING FLAP

The extruder barrel of all extruder types is heated with the SML advanced heating system. A gravity-closing flap prevents the escape of hot air from the system, thus retaining the heat in the barrel. Effective melt filtration for the removal of impurities, unmelted or cross-linked particles, is most important. SML installs manual or hydraulic piston filters in its stretch film lines.

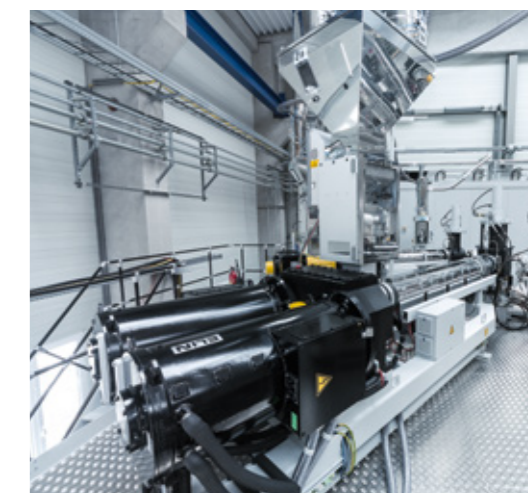

HSE 90/33

## Your Advantages

- ✓ Wide range of screw diameters from 45 – 180mm
- ✓ Water-cooled AC motors as a standard
- ✓ Effective melt filtration
- ✓ For 2-inch and 3-inch cores
- ✓ Extremely short cycle times

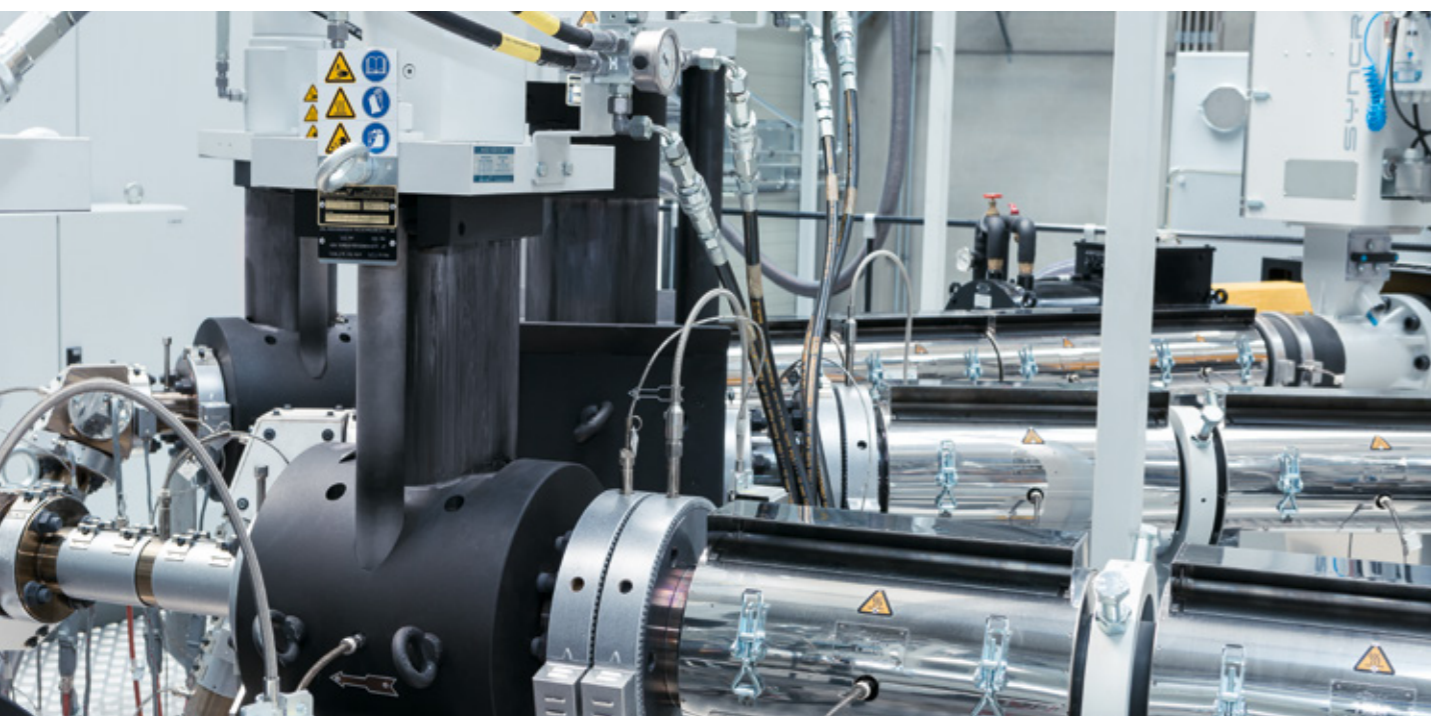

EXTRUSION UNIT ▲

**EXTRUDER CHARACTERISTICS**

	45/28	60/28	75/33	90/33	HSE90	120/33	135/33	150/33	180/33
<b>Screw rpm</b>	289	272	294	226	350	146	139	139	114
<b>No. of zones</b>	3	4	5	5	5	6	7	8	9
<b>Output in [kg/h]*</b>	95	240	480	600	950	950	1,050	1,250	1,600

\* For reference only. Depending on the drive power installed, actual output may differ.

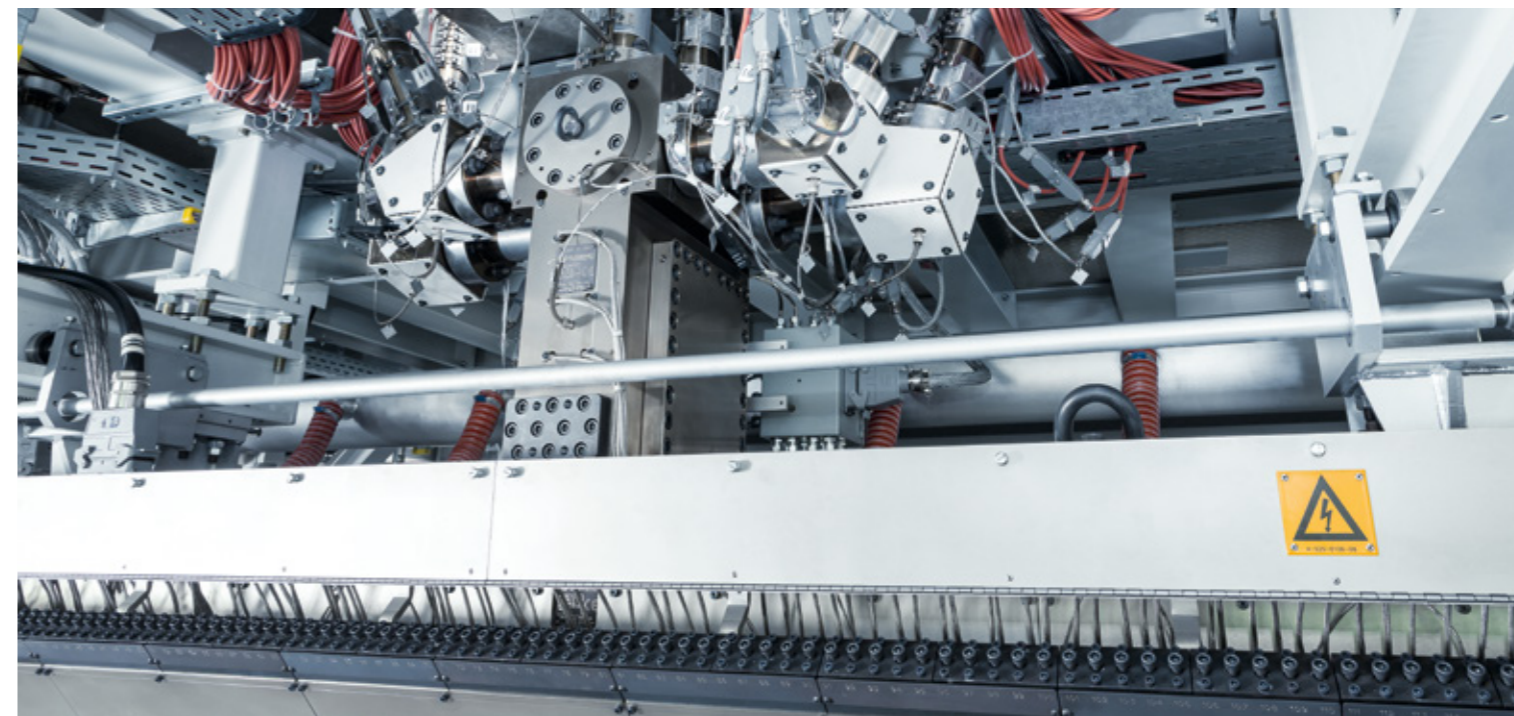
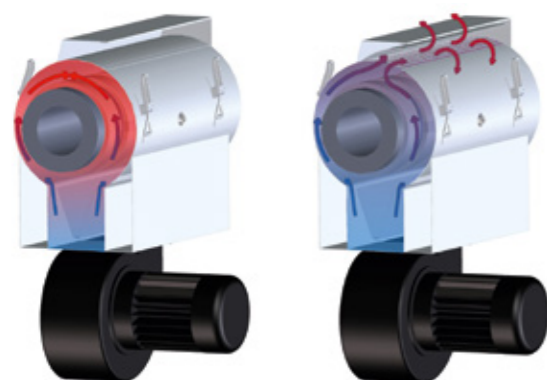

FEEDBLOCK AND FLAT DIE ▲

**3 Feedblock and flat die**

As the leading supplier of stretch film lines, SML relies exclusively on respected partners for its feedblocks and flat dies.

with T-channels are capable of incorporating fixed or variable internal decking systems. This feature provides an efficient means of varying the net film width. Depending on the manufacturer, dies are either chrome or nickel plated, but in both cases, automatic die-control via thermal heated bolts is standard.

Automatic die

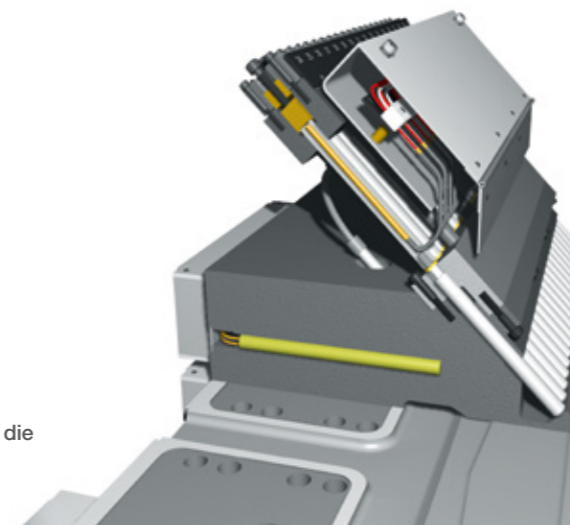

**READY FOR MULTIPLE LAYERS**

The stretch film production trend is towards more sophisticated film structures with a higher number of layers than in the past. This is mainly related to the higher number of extruders used for these films. Today, five, seven or even 13 layers have become standard, but on request SML builds lines with more layers, utilising MicroLayer or NanoLayer™ technology. Co-extrusion flat dies

**EDGE ENCAPSULATION SYSTEM**

SML suggests edge encapsulation especially for the production of thin film at high line speeds. An additional extruder feeds a divided melt stream of LLDPE to the edges of the die. Edge encapsulation stabilises the melt curtain and thus reduces the danger of trim loss during production. A return on the additional investment required for the edge encapsulation system is obtained very quickly, as the downtimes caused by edge breaks during conventional production are avoided and higher running speeds are possible.



DIE SPLITTING SYSTEM ▲

#### DIE SPLITTING SYSTEM

SML's die splitting system enables quick and safe die opening for cleaning purposes. The die remains in its original position in the machine and continues to be heated.

#### EDGE PINNING

A combined electrostatic and pneumatic pinning system fixes the film to the chill roll surface. The adjustable static power and air pressure, as well as easy positioning, allow precise pinning and therefore an excellent film edge contact on the chill roll.



Edge pinning system

### Your Advantages

- ✓ Ideal for sophisticated film structures
- ✓ High-end components
- ✓ Die-control via thermal heated bolts and SML's Booster Technology

#### VACUUM BOX

The vacuum box, mounted directly on the die body, consists of two or three chambers. The prechamber extracts the air stream caused by the rotating chill roll, while the main chamber maintains a low air pressure between the extruded film and the chill roll. The third chamber is at the left and right end of the box. It takes special care of the edges of the film. In addition, the length of the melt curtain can be adjusted before it touches the chill roll. All of the chambers are equipped with separate speed-controlled suction fans.



Bi-vacuum box



CHILL ROLL UNIT ▲

## 4 Chill roll unit

Apart from the extrusion section in combination with the vacuum box, the condition of the chill roll unit has a significant influence on the final product quality. Parameters such as the position relative to the flat die, the chill roll temperatures and surface have a direct effect on the film. In this connection, the vast experience obtained by SML with the delivery of a large number of stretch wrap film lines facilitates the rapid determination of the optimum parameters for specific customer requirements.

#### CHILL ROLLS WITH SPECIFIED SURFACE PROPERTIES

The chill roll unit consists of one or two cooling rolls for which careful surface selection is vital. The electro-chemically matted surface of the first chill roll provides an extremely homogeneous surface and a very high cooling capacity. Furthermore, this surface allows easy film release upon departure from the chill roll due to a well positioned release roller. The second chill roll has a polished surface for highly effective stretch film post-cooling. Both rolls are chromium-plated and equipped with separate water tempering systems and drives.

#### ECONOMIC FILM THICKNESS REGULATION

SML places the thickness gauging unit directly on the chill roll frame behind the chill roll. The shortest achievable distance from the die lip to the measuring point ensures minimum reaction times for extremely economic film thickness regulation. In response to the different regulations in customer countries and specific product needs, SML supplies automatic gauging systems either with infrared, X-ray or beta-ray sensors.



Chill roll unit with thickness measuring unit

After leaving the chill roll, the film is transported to the winder via cut-resistant guiding rolls. These have a specially-hardened surface for a high film grip and a long service life!

### Your Advantages

- ✓ Highly customisable chill roll parameters
- ✓ Separate water tempering systems, separate drives
- ✓ Gauging systems with infrared, X-ray or beta-ray sensors

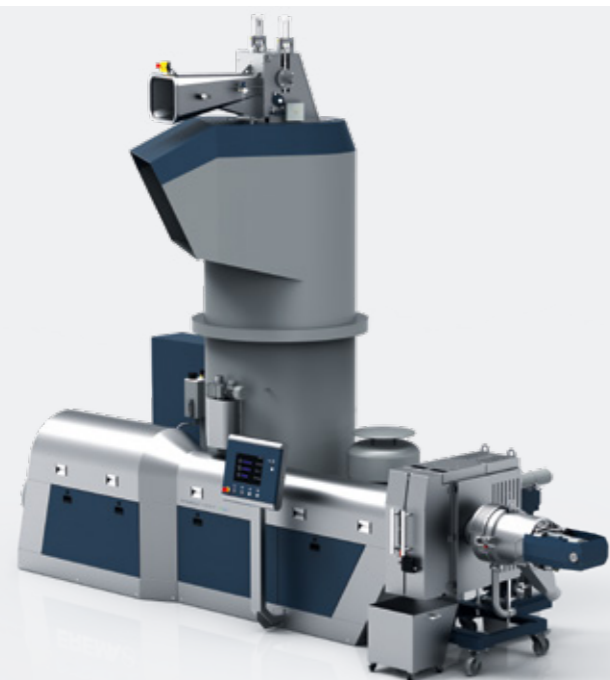

RECYCLING UNIT ▲

## 5 Trim handling system

Stretch film production is only economic with complete trim recycling. With SML's stretch wrap film lines, the edges are cut off directly at the winder entrance and, depending on the winding system, bleed trims are also removed. Fluff and pellet re-feeding are the two possibilities for re-feeding edge and bleed trims back to the process. In both cases, a blower system transports the trims, either to the grinder in the fluff re-feeding system, or directly to the recycling unit.

### FLUFF RE-FEEDING

In the fluff re-feeding system, the trims are sucked through a grinder and then transported to a vertical scraptruder. This feeds the fluff together with virgin material directly to an extruder to form a core layer. Fluff re-feeding is the more energy-efficient and material-compatible method, as no additional melting is involved.

### PELLET RE-FEEDING

At pellet re-feeding, the trim is melted and re-pelletised in a separate recycling unit and then sucked to the dosing system of an extruder. This process offers greater flexibility with regard to the use of recycled pellets on different extrusion lines. It is a convenient solution in case frequent colour changes are required and for the recovery of waste and off-spec rolls.



Fluff re-feeding unit

## Your Advantages

- ✓ Complete trim recycling
- ✓ Efficient and flexible solutions
- ✓ Blower system for trim transport



## 6 Winding Systems

The winder is the heart of a stretch film line and decisive in terms of the overall line performance. Before entering the winder, the film is oscillated in an overhead position by a frame, in order to ensure a perfect film roll surface. Both the oscillation distance and the speed are adjustable.

### CONSTANT INNOVATION, CONSTANT UPGRADES

SML is proud of its peak performance winders, which are the result of many years of intensive, in-house technological development work. Every new product, idea or requirement, which is spotted in the market, or is the subject of a customer inquiry, is passed on to the R&D department. Following a detailed evaluation, SML then upgrades its winders with corresponding, new features.

### THREE DIFFERENT WINDING SOLUTIONS

SML has created three different winding systems for the production of stretch wrap film. All of these have a solid, vibration-free steel frame construction, which is able to resist the dynamic forces generated at high production speeds.

The heart of a stretch film line



## “Shaftless” winder W3000-4S

This highly sophisticated winder does not produce bleed trims and thus utilises the extruded film in a most effective manner.

The incoming film is simply cut by single blades to the final film width, e.g. 6 x 500mm, and then passes an equal number of separation frames.

### UNIQUE WINDING SYSTEM

Directly after the satellite roll, the film is wound onto the winding core via a driven contact roll. This core is only clamped by special chucks and not supported by a winding shaft. Therefore, the winder is unique, as it is shaftless and thus offers the major advantage of no critical revolution speeds due to dynamic deflections. Nevertheless, the winder still has a turret with four winding stations for extremely short cycle times and a perfect winding quality up to the end of the roll with an ultimate short tail.

### THIN CORE TECHNOLOGY

These features are supported by an additional contact roll, which follows the roll along the cutting index. The winder W3000-4S is able to handle 2-inch and 3-inch cores with both standard and thin wall thicknesses (thin core technology).

## Your Advantages

- ✓ Bleed trim-free, highly effective material usage
- ✓ For 2-inch and 3-inch cores
- ✓ Extremely short cycle times



## “Workhorse” winder W4000-2S

This is the primary selling stretch film winder and can be delivered in single, double and triple-turret versions with net film widths of 1,500 – 6,000mm.

Simplicity, great width flexibility and top speeds for machine and jumbo rolls represent the key to high performance.

### 3-INCH WINDING CORE

The film passes a satellite roll and is then wound onto a 3-inch winding core via a driven contact roll. Each turret is equipped with only two winding shafts and offers sufficient cycle time for typical machine rolls.

### PRODUCTION SPEEDS UP TO 800 M/MIN

One extremely valuable benefit is the ability to produce jumbo rolls with a maximum diameter of 425mm and a weight of 60kg. This winder is capable of handling actual production speeds up to 800 m/min and comes with the thin core technology.

## Your Advantages

- ✓ Single, double, and triple-turret versions
- ✓ Great width flexibility from 1,500 – 6,000mm
- ✓ Production of machine and jumbo rolls at high speeds

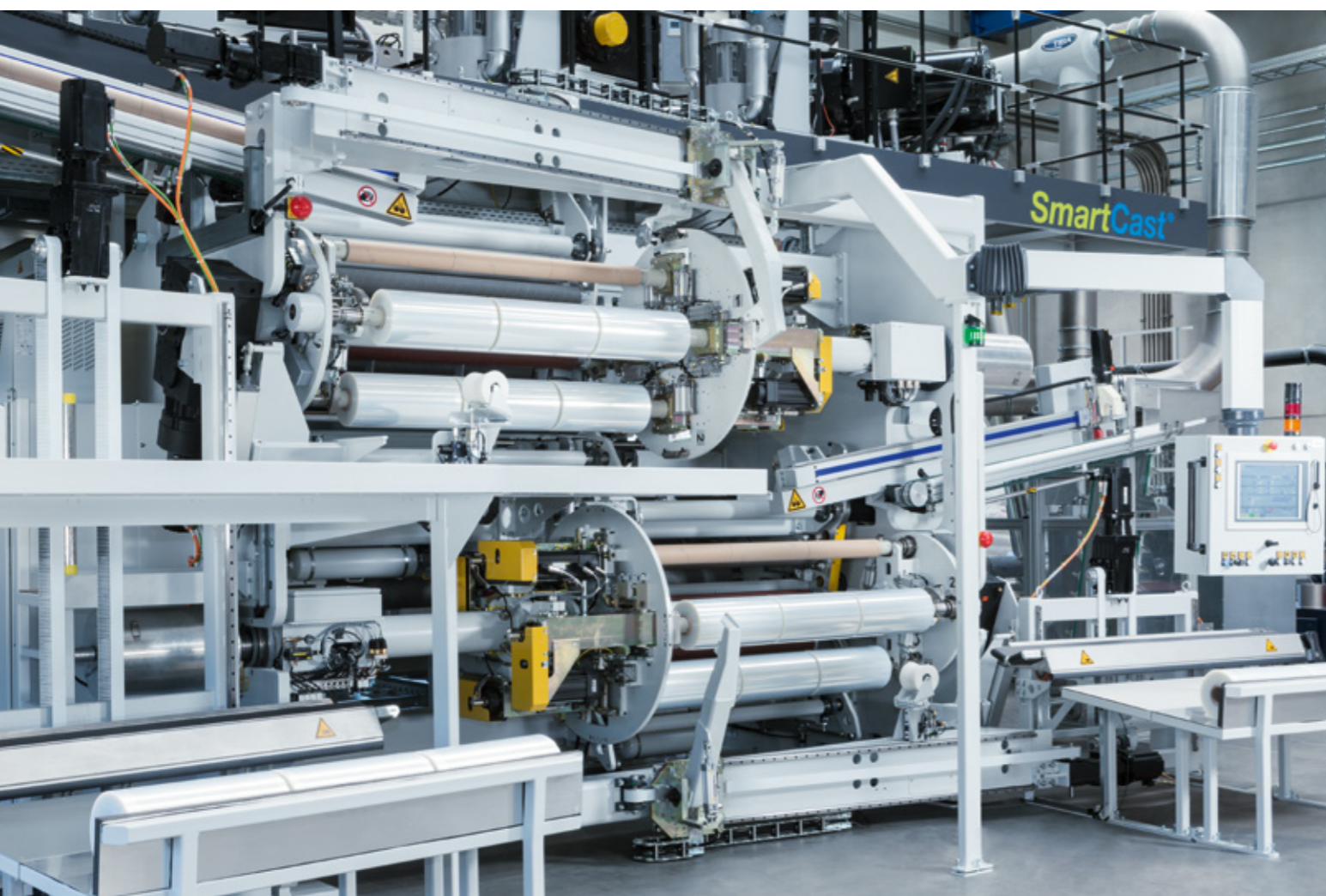

## “Multitalented” winder W4000-4S

As the technology leader, SML carefully analysed the possibility of producing a single winder design, which would meet all the current market requirements and anticipated future developments.

The result is the unique and most versatile winder W4000-4S, which is based on the company’s vast experience in stretch film and the feedback received from top-level customers.

### THE WINDER W4000-4S COMBINES FEATURES SUCH AS:

- 4 winding shafts in each turret
- Single, double or triple-turret design, depending on the width
- A separate contact roll for the ultimate, short tail
- Suitability for 2-inch hand rolls, 3-inch machine rolls and jumbo rolls
- Thin core technology
- Coreless operation available
- Modified edges available
- K-AP technology

## Your Advantages

✓ All these features make the W4000-4S winder a stretch film winding benchmark

Winding	winder W3000-4S	winder W4000-2S	winder W4000-4S
Thickness range	8 - 35µm	8 - 50µm	8 - 50µm
Max. mechanical speed	650 m/min	850 m/min	850 m/min
Winding width	4 - 6 x 500mm	3 - 12 x 500mm	3 - 9 x 500mm
Part roll width	400, 450, 500mm	variable	variable
Winding on 2-inches	yes	no	yes
Winding on 3-inches	yes	yes	yes
Coreless winding	no	yes *	yes
Max. mechanical diameter 2-inches	180mm	no	180mm
Max. mechanical diameter 3-inches	400mm	425mm	425mm
No. of winding stations per turret	4	2	4
No. of winding turrets	single	single / double / triple	single / double / triple
No. of winding shafts	shaftless	2 / 4 / 6	4 / 8 / 12

Minimum cycle time	20s	60s	15s
Film tail	very short	standard	ultra short
Bleed trim	bleed trim-free	yes	yes

Winding tension	0 - 100 N/m	0 - 100 N/m	0 - 100 N/m
Contact roll pressure	50 - 500 N/m	50 - 500 N/m	50 - 500 N/m

Core and roll handling manual	no	optional	optional
Core and roll handling automatic	yes	yes	yes

\* With centre support



## Stretch Wrap Film Products

Pallet stretch wrap film represents the biggest stake of the cast film market. Compared with all other films used for palletising solutions, it has the lowest unit wrap weight.

For that reason, it is the most cost-effective way for the safe packaging of items on pallets. In addition, pallet stretch wrap film is also eco-friendly, since it can be produced from nearly 100 percent recycled materials.

### WIDE RANGE OF DIFFERENT FILM TYPES

In response to the varied requirements for different transportation methods and distances, a wide range of stretch film qualities has been created and continues to expand. SML extensively uses its in-house testing facilities and its demonstration lines to develop new stretch wrap films in close cooperation with its partners. Today, stretch wrap products extend from simple 3-layer hand films, to machine film grades with very high pre-stretch rates and dart-drop values.

### HIGH VOLUMES – HIGH EFFICIENCY

At stretch wrap film production, over 80 percent of the production costs relate to raw material. This was SML's primary reason for the development of high-performance stretch wrap film lines with the highest output capacities. In combination with cost-saving formulations, reliable machinery, high safety standards and low waste rates, this guarantees maximum line efficiency and low unit costs.







E-CONTAINER ▲

## 7 SMILE® control system

SMILE is SML's generic machine control and operation concept. It stands for all-encompassing automation, providing machine control systems with the highest usability in combination with outstanding capacities for profound process management and monitoring.

The end-to-end integration of third-party systems, overall line effectiveness, operator-friendliness as well as tailor-made and flexible software solutions are the key elements of SMILE.

SMILE is developed as a whole in-house and is integrated one hundred percent in SML's extrusion lines. It is the highly precise, centralised control and synchronisation of all components in an extrusion system, which is blazing the way to new manufacturing concepts as well as delivering product properties, line efficiency and output volumes.

### INTUITIVE MACHINE CONTROL CONCEPT

SMILE is an integral part of SML's coherent and user-friendly overall line concept; machine control and operation is highly intuitive and self-explanatory:

- A central control station system for the highest operating comfort and the visualisation of all processes
- Reduced training efforts and error rates at operator level, less personnel required
- Remote control, remote update and remote service for minimised maintenance-costs, multi-client / multi-user capability

### OPTIMISED PRODUCTION EFFICIENCY

One key purpose of SMILE is the increase in the Overall Equipment Effectiveness (OEE) through optimised production processes.

- Optimised use of raw materials, preventing waste
- Faster start-up of production
- Minimised times for product change-overs – customisable assistant for product changes



Control panel

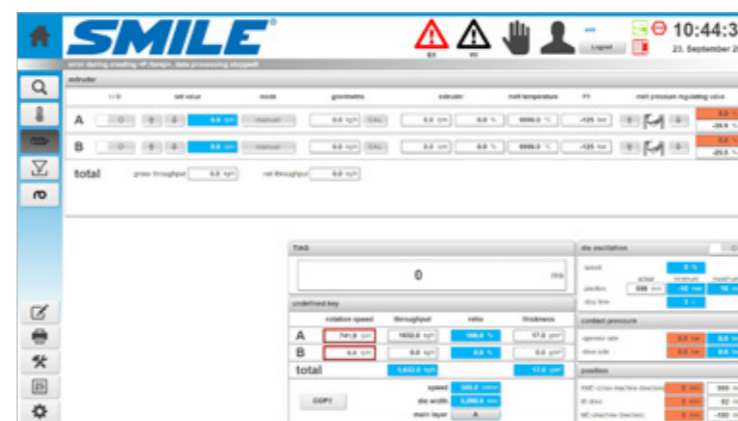

### SYSTEMATISED QUALITY CONTROL

In close interaction with SML's data collection and analysis system bitWise, SMILE is an efficient tool to keep output quality stable and to optimise output properties.

- Formula recipe system to copy production parameters
- Documentation and detailed reporting of production processes
- Automatised alarm functions via e-mail or text message for quick debugging

### INTERCONNECTIVITY AND THIRD-PARTY INTEGRATION

SMILE has open interfaces that allow the web-based data exchange with third-party machines and systems.

- Open to interconnecting with systems like Enterprise Resource Planning (ERP), Quality Assurance (QA) or SML's data analysis tool bitWise
- Based on open standards like HTML5 and UPC-UA
- Complete end-to-end process control beyond SML extrusion lines

### INTEGRATED ALL-IN-ONE CONCEPT

It is SMILE's all-in-one concept that helps to create completely new types of extrusion solutions, making one single operator-friendly step out of the most complex production processes. The control of temperatures, speeds and pressures on SML extrusion lines is highly centralised. All of the line modules and motors are perfectly interconnected and synchronised with each other.

### CENTRAL CONTROL STATION SYSTEM

SMILE's central control station system allows the management of all of the production processes from the wide touch screen attached to the line. As SMILE is web-based, all of the production and maintenance processes can be entirely remote controlled, i.e. from a PC or even a smartphone. The system is fully multi-client and multi-user capable, different types of users can log-in simultaneously.

### OPEN FOR CUSTOMISATION

Developed in close consistency with the hardware components of SML's extrusion lines, SMILE is highly customisable. It is SML's flexibility that offers a wide range of opportunities if customer-specific solutions are required.

### SOFTWARE 100 % DEVELOPED IN-HOUSE

Above all, it is SML's long-standing in-house competence in the field of automation and machine control that provides loads of innovative functions tailored to specific customer requirements. In-house developed, state-of-the-art and dynamic controller systems always allow running the machines at their very best performance-level – considering both economic and environmental aspects. All of SMILE's software solutions are developed by SML technicians. Last but not least, it is SML's concentrated know-how in any aspect of automation, that helps to create the extrusion solutions of tomorrow.

### SMILE SOFTWARE FEATURES

- ▶ Central control station system for all production processes
- ▶ Full interconnectivity – global UPC-UA, programmed on HTML5, open interface to other machines and systems
- ▶ Remote access for operators and service teams – worldwide via the internet, from any PC, laptop or most smartphones
- ▶ Multi-client / multi user capability – simultaneous access for different type of users, simple assignment of permissions
- ▶ Highest comfortability – visualisation of all production processes on a wide screen
- ▶ Worldwide possibility of remote update for customisation and technical support

### SMILE HARDWARE FEATURES

- ▶ The hardware components of SMILE are supplied by B&R Industrial Automation GmbH, a member of the ABB group, a global leader in automation.

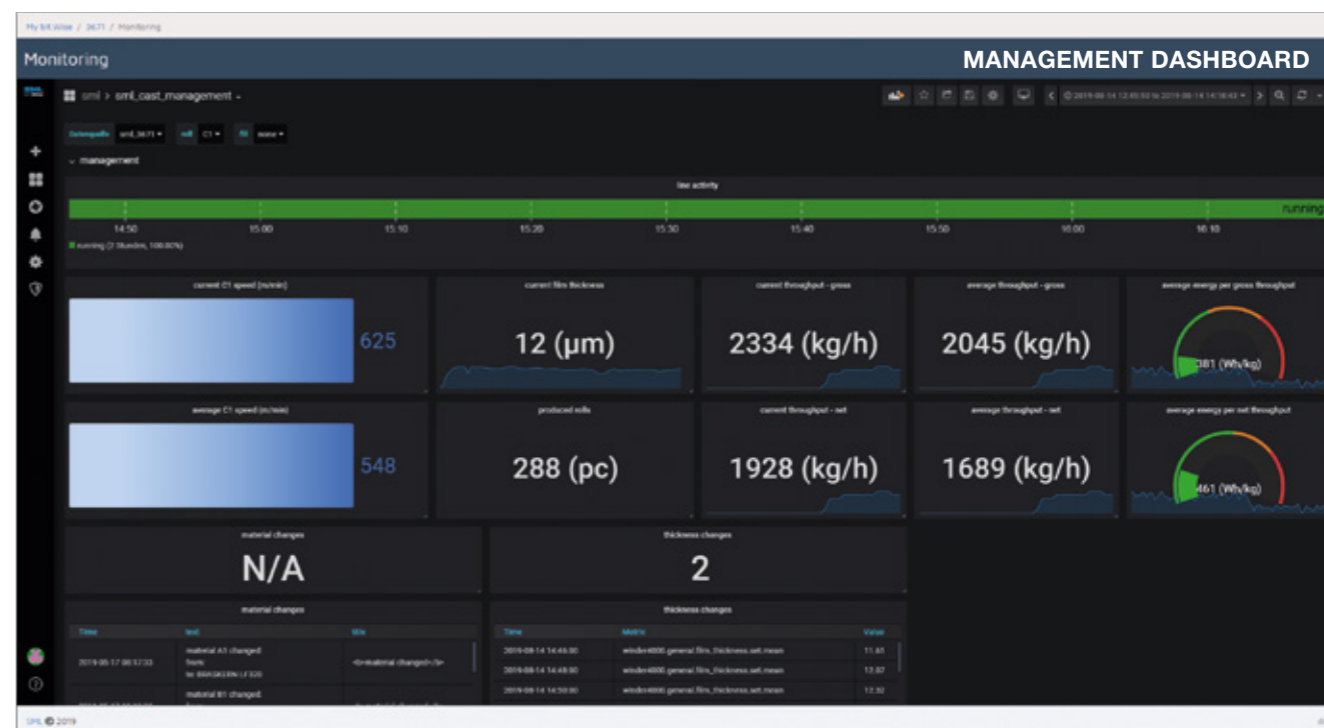
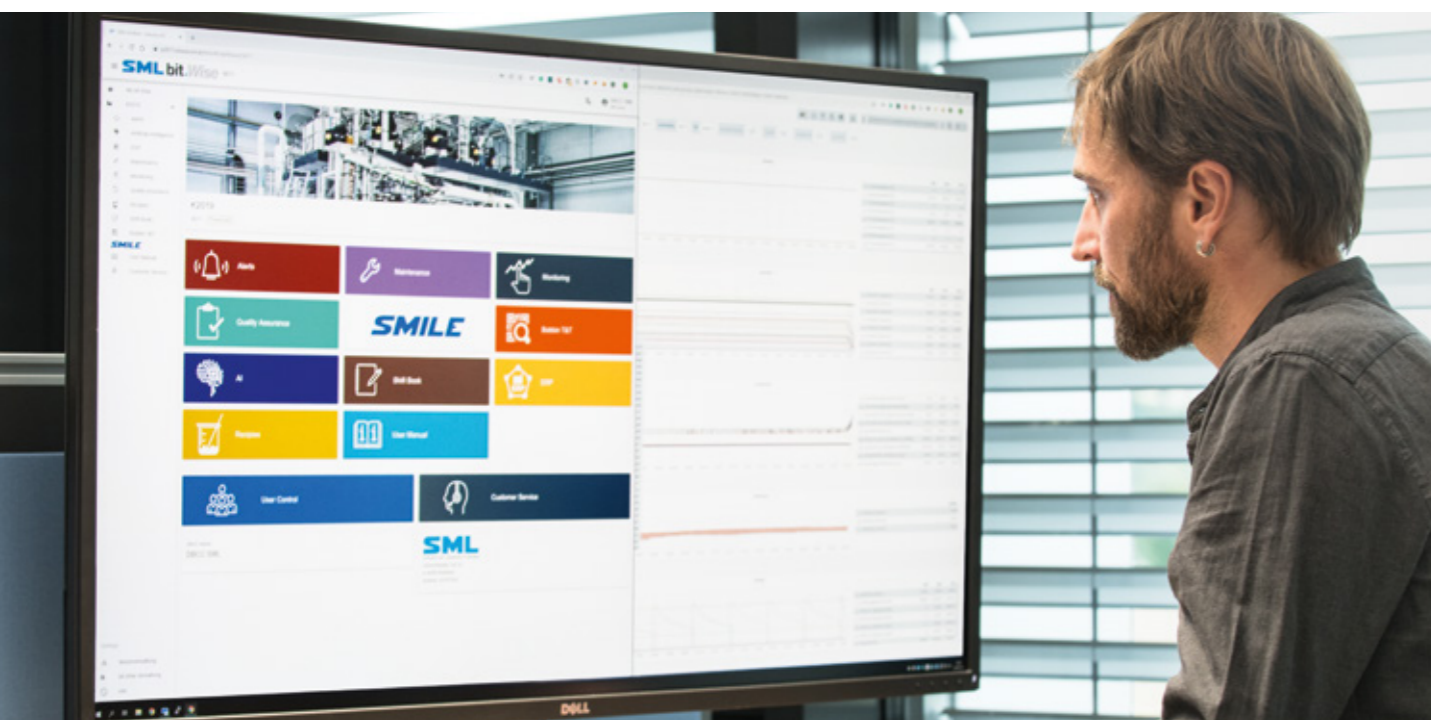

## bitWise data analytics

bitWise is SML's digital transformation solution for extrusion lines. It breathes life into the buzzword **"Industry 4.0"**. bitWise provides for a wide range of entirely new opportunities for data driven decisions with a clear focus on the optimisation of production processes and the final product. Completely developed in-house, it incorporates SML's decades of experience in automation with the latest technologies in data analytics and visualisation.

### IN-DEPTH PROCESS INSIGHTS

SML extrusion lines are equipped with hundreds of data-generating sensors. Following the principle of **"stop guessing – start knowing"**, bitWise collects, records and visualises this data up to 10 times per second. This gives manufacturers a 360 degree in-depth view of all of the details involved in a production process, both in the present and in the past.

### OPTIMISING QUALITY

bitWise is a powerful tool to optimise any aspect of the production process with a direct effect on product quality.

- In-depth monitoring of all quality-related process parameters, allowing quick corrective action
- Comprehensive tracking and documenting of product quality
- Making quality reproducible

3871  
**qhObwH**

Position:	B4_1
Width:	500
Weight:	17.6
Diameter:	234
Endtime:	10.9.2019, 15:55
Length:	2665
Length difference:	0
Rolls:	4
Order Nr.:	bitWise
Quality:	excess length
Recipe:	12mic_K-Show
Shaft:	4
Shift:	KW37
Starttime:	10.9.2019, 15:51
Station:	B
Tags:	show, lab
Thickness:	12.6
Trial:	K-SHOW_12mic
Trigger:	meter

SHOW METRICS

GENERATE A REPORT

### MAXIMISING OUTPUT

Data recorded, aggregated and visualised by bitWise helps to raise overall line utilisation and deliver a faster return on investment (ROI).

- Discovering hidden or unused output capacities
- Preventing downtimes by detecting potential problems at an early stage
- Minimising maintenance times through optimised scheduling and structured access to documentation and service support

### MINIMISING PRODUCTION COSTS

bitWise is the central tool to measure and visualise all production-related costs. It forms a strong and reliable basis for the continuous cost-optimisation of production processes.

- Detailed monitoring and reporting of energy and raw material consumption
- In-depth optimising, tracking and reporting of Overall Equipment Effectiveness (OEE)
- Full end-to-end cost transparency through third-party integration

### ON-PREMISE SOLUTION

bitWise is a 100 % on-premise solution. Your data stays in your company, on dedicated and secured hardware, no cloud services required.

### CUSTOMISATION AND RETRO-FIT

As with most technologies developed by SML, bitWise is highly customisable. bitWise can be retro-fitted to many existing SML extrusion lines optimising production processes, cutting costs, raising the OEE and ROI of existing investments.

### OPEN FOR VERTICAL INTEGRATION

Extrusion lines are a key part in a wider production chain. For end-to-end optimisation, bitWise supports data exchange and vertical integration with third-party systems, e.g. Manufacturing Execution Systems (MES), Enterprise Resource Planning (ERP) or Quality Assurance (QA).

NOTES:

# SML

EXTRUSION LINES – ENGINEERED TO PERFORM ▶

#### **SML - Head Office**

SML Maschinengesellschaft mbH  
Gewerbepark Ost 32  
4846 Redlham, Austria  
Phone: +43 7673 90999 0  
E-mail: [sml@sml.at](mailto:sml@sml.at)  
[www.sml.at](http://www.sml.at)

#### **SML - Machinery Far East Sdn Bhd**

(1029958-P)  
1201 Block B, Menara Amcorp  
No.18 Jalan Persiaran Barat  
46050 Petaling Jaya  
Selangor Darul Ehsan,  
Selangor, Malaysia  
Phone: +60 3 7955 9098  
Fax: +60 3 7955 9981  
E-mail: [yen@sml.at](mailto:yen@sml.at)

#### **SML - Moscow Office**

Ogorodny proezd, 5  
Building 6, office 504  
127254 Moscow  
Russia  
Phone: +7 495 618 8007  
Fax: +7 495 619 5961  
E-mail: [kna@sml.at](mailto:kna@sml.at)

#### **SML - Beijing Office**

Unit 1410, Landmark Tower  
No. 8 North Dongsanhuan Road  
Chaoyang District  
100004 Beijing, P.R. of China  
Phone: +86 10 6590 0946  
Fax: +86 10 6590 0949  
E-mail: [sml@sml.bj.cn](mailto:sml@sml.bj.cn)

#### **SML - North America Service Inc.**

Suite 204  
85 Eastern Avenue  
Gloucester MA 01930  
USA  
Phone: + 1 978 281 0560  
E-mail: [jom@sml.at](mailto:jom@sml.at)

100%  
eXtrusion  
CAST FILM LINES

ANALYSES | DEVELOPMENT

PRE-TESTED PERFORMANCE | DELIVERY ON TIME

SERVICE SUPPORT | CUSTOMER SATISFACTION

[www.sml.at](http://www.sml.at)